

ArcelorMittal Europe - Long Products
Sections and Merchant Bars



ArcelorMittal

Corrosion protection

of rolled steel sections using hot-dip galvanization



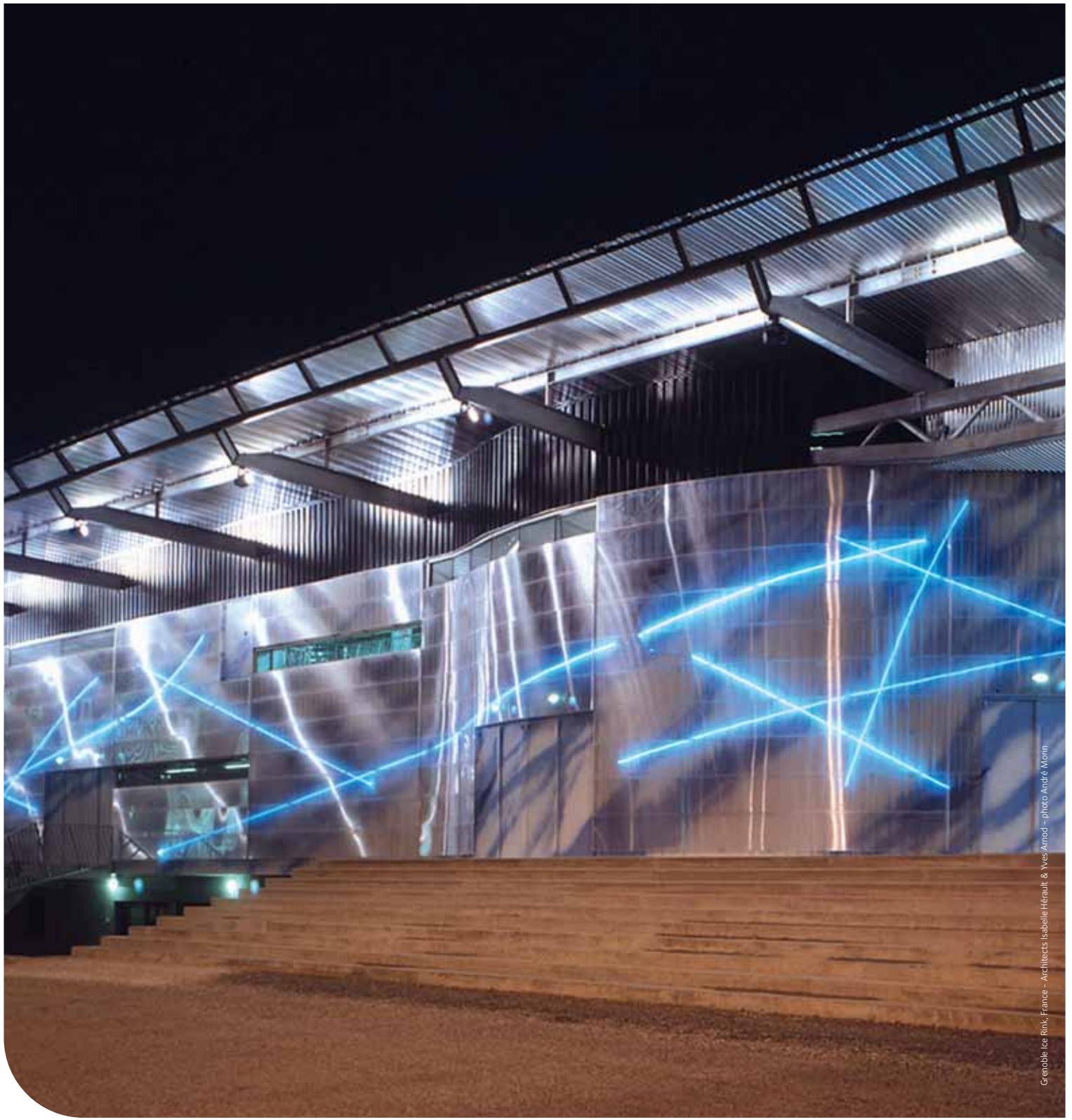

Grenoble Ice Rink, France - Architects Isabelle Héraul & Yves Arnod - photo André Morin

Thanks to its exceptional physical and mechanical characteristics, steel is most popular amongst designers

Contents

Foreword	3
1. Risk of corrosion and protection period	5
2. Corrosion protection methods	8
3. Hot-dip galvanizing	10
4. Characteristics of hot-dip galvanizing of steel structures	17
5. Requirements for materials	21
6. Requirements of structures suitable for hot-dip galvanizing	25
7. Requirements for the fabrication of steel structures	31
8. Requirements for hot-dip galvanizing	33
9. Duplex systems	35
10. Cost effectiveness	37
References	39
Technical advisory & finishing	42
Your partners	43



Düren Car Park, Germany

Foreword

When it comes to choosing materials, steel, because of its exceptional physical and mechanical characteristics, is the most popular amongst designers. It can be used to rapidly build economical, durable, and safe structures. The steel used to make hot-rolled sections, which can themselves be indefinitely recycled, is made from recycled scrap. It is particularly suitable for machining and shaping. However, it tends to react with agents in the atmosphere to form stable thermodynamic bonds – ferrous oxides and/or salts.

The ability of steel to revert to its natural or original state is called corrosion.

In layman's terms: steel rusts!

The primary quality of steel i.e. its ability to retain its physical and mechanical strength, or in the case of a steel structure, its load bearing capacity, is generally long-lasting and is only compromised when corrosion reduces its cross section to such a degree that safety is adversely affected.

The service life of a structure depends on the rate of reaction between the steel and its environment. These reactions depend on the nature and concentration of the corrosive agents present.

Corrosion protection of structures must therefore be considered as intervening in this process in order to prevent the reaction or greatly reduce the rate.

Large numbers of steel structures, some of them a hundred years old, which have benefited from the combination of a suitable corrosion protection treatment and regular maintenance, show impressively the potential of steel. However, these types of structures, requiring high maintenance costs, are no longer acceptable today.

New requirements govern the design of the steel structures of the twenty-first century:

- Environmental protection policies enforced at both the national and international level have led to a considerable reduction in the amount of corrosive load in the atmosphere over the last twenty years. This has resulted in a noticeable drop in the average corrosion rate of steel and zinc as well as improved resistance of coating systems.
- The design of steel structures is substantially improved through the effectiveness of welding procedures and the vast range of rolled sections available thus contributing positively to ensure that corrosion protection systems have long service lives. Maintenance and renovation costs continue to fall because the amount of exposed surface area has been greatly reduced and ease of access improved. The ability of new coatings to resist the stresses in their surroundings has been increased considerably. New inexpensive coating methods are employed in fabrication shops and on construction sites.

- Zinc baths have sufficient capacity and are large enough to allow widespread hot-dip galvanization of steel structures involving large components.
- Combining the hot-dip galvanization technique with adapted paint systems for zinc coatings – so called duplex systems – renders maintenance unnecessary with, in most cases, the corrosion protection not requiring any attention for the entire service life of the structure.
- Corrosion protection is becoming an integral part of the fabrication process for steel structures.



Erco high rack warehouse, Lüdenscheid, Germany

1. Risk of corrosion and protection period

1. Risk of corrosion

The risk of corrosion of steel structures emanates from the surrounding atmospheric conditions.

The nature and extent of any corrosion is linked to the amount of time that metal surfaces are exposed to moisture and to the amount of air pollution.

The exposure time to moisture, which is the amount of time that the relative humidity of the air is > 80% at an ambient temperature of >0°C, is the main determinant as regards atmospheric corrosion and corrosion rate of metals.

The absence of moisture considerably slows down the corrosion rate of steel and zinc even in the presence of high concentrations of gaseous (SO₂, NO_x etc) or solid pollutants (dust containing aggressive particles).

Over the last few years, the complex influence of atmospheric pollutants on the corrosion rate of unprotected structural steel and zinc has been analysed as part of several European research programmes [1].

The result of this work has led to the drafting of the standard ISO 9223 "Corrosion of metals and alloys – Corrosivity of atmospheres – Classification". The basic information containing the classifications for the corrosivity of atmospheres and the corrosion rates of plain carbon steel, zinc, copper, and aluminium, determined as a function of the corrosive load, is sufficiently accurate to allow the protection period of paints and zinc coatings to be calculated in a practical fashion.

This standard was also used as the basis for the classification of the corrosivity of ambient atmospheric conditions in EN ISO 12994-2.

EN ISO 12944 characterises atmospheric conditions in the form of corrosivity categories based on figures of the loss of mass or thickness per unit surface area of steel or zinc during the first year of exposure to different atmospheric conditions (Table 1).

Examples of characteristic ambient conditions help to assign the appropriate corrosivity category to the structures and facilitate the determination of the required corrosion protection, by emphasising the protection period.

Apart from unusual circumstances, this method allows a sufficiently reliable assessment to be made of the corrosive load for the majority of steel structures.

Table 1 Risk of corrosion – Classification of ambient conditions according to EN ISO 12994-2.

Corrosion risk category	Loss of thickness of zinc in the first year (µm)*	Examples of typical environments	
		External	Internal
C 1 Very low	Less than 0.1	–	Isolated building. Relative humidity of air: less than 60%
C 2 Low	0.1 – 0.7	Slightly polluted atmosphere, dry climate e.g. rural areas	Non-isolated building with temporary water condensation e.g. warehouses, sports halls
C 3 medium	0.7 – 2.1	Urban or industrial atmosphere with low level of SO ₂ pollution or coastal areas with low salinity	Premises characterised by high relative humidity of the air and impurities, e.g. breweries, laundries, dairies
C 4 high	2.1 – 4.2	Industrial or coastal atmosphere with low salinity	Swimming pools, chemical factories
C 5 Very high I	4.2 – 8.4	Industrial atmosphere with considerable humidity and aggressive atmospheres	Buildings or areas with almost continuous water condensation and high levels of pollution
C 5 Very high M	4.2 – 8.4	Coastal area with high salinity	

* can also be expressed in loss of mass (g/m²)



Architects: Heerdt, Jahn - Photo: K. Heiberg

The levels of airborne SO_2 are measured at numerous locations in Europe. European research has also allowed the relationship between the corrosion rate of zinc, the levels of airborne SO_2 and the wetting time / amount of rainfall, to be analysed [2].

The loss of zinc as a function of the concentration of airborne SO_2 has been plotted on a graph on the basis of this research (Figure 1). This shows a simplified, but perfectly useable version for determining the corrosivity category according to EN ISO 12944-2, on the basis of the figures available for SO_2 concentrations [$\mu\text{g}/\text{m}^3$] at various locations.

However, it should be emphasised that the corrosivity category determined in this way characterises the corrosive load at the macroclimatic level. Particular microclimatic features, perhaps deriving from emission sources in the vicinity of the steel structures, or the use of an unsuitable design for ensuring corrosion protection, are not included and must be specified by the owner, for example, in the case of structures built for the chemical industry.

In Europe, the considerable reduction in the amount of airborne SO_2 has resulted in a substantial decrease in the corrosive load. The average annual corrosion rate of zinc for 1992/1993 was $8 \text{ g}/\text{m}^2$ or $1.1 \mu\text{m}$ [3]. These figures are still valid today.

Figure 1 Loss of zinc as a function of SO_2 pollution (according to Knotkova/Porter)

Loss of zinc/year [μm]

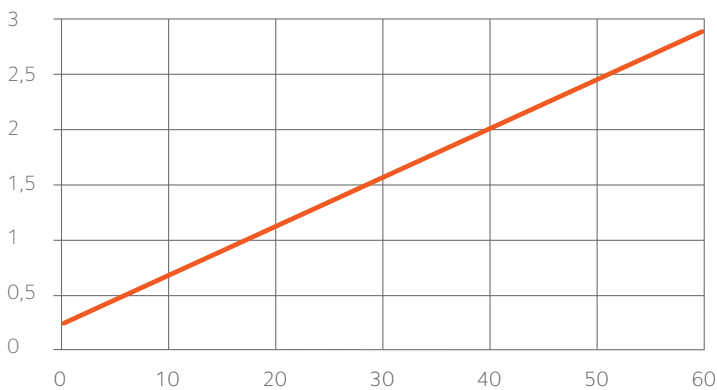

Average annual figure of sulphur dioxide [$\mu\text{g}/\text{m}^3$]

Santiago-Bernabeu Stadium, Madrid, Spain



2. Protection period

The protection period of coatings is defined in EN ISO 12944-1 as the expected service life up until the moment where the system needs attention for the first time.

EN ISO 14713 defines the “protection period up until attention is first needed” of zinc coatings as being the time between the application of the first coating and the moment when it first needs maintenance in order to ensure the protection of the base material.

The protection period is a vital factor when selecting and defining corrosion protection systems. This technical concept helps the owner of the structure to specify his maintenance schedule.

The protection period is not a guarantee period. Generally, the guarantee period, a legal concept, is shorter than the protection period. There is no link between these two concepts.

Nowadays, it is possible to imagine corrosion protection not requiring any or hardly no attention for the entire service life of hot-dip galvanized steel structures, even if exposed to poor weather conditions.

The protection period of a zinc coating depends mainly, for a given corrosive load, on the thickness of the applied coat. Figure 4 uses the figures for loss of thickness of zinc indicated in Table 1 to show the relationship between the protection period / the thickness of the zinc coat and the corrosive load. It can be generally assumed that there is a uniform loss of zinc across the entire coated surface. If we consider the macroclimatic corrosive charge of category C3, currently valid in Europe, and characterised by a zinc loss of between 0.7 and 2.1 μm during the first year, we obtain a protection period of at least 40 years for a minimum zinc coat thickness of 85 μm , as specified in EN ISO 1461 (Table 3) for steel product thicknesses of >6 mm.

We have to once again state that the protection period determined in accordance with the method above is only valid for the corrosive loads considered at the macroclimatic level.

Special microclimatic features and higher loads particular to the structure, such as an accumulation of dust with a prolonged exposure to moisture can considerably reduce the protection period.

It is now possible, as a result of the clear definition of ambient atmospheric conditions - corrosivity categories - and access to measurements used as the basis for calculating the protection period, to properly design suitable corrosion protection systems in accordance with EN ISO 12944-5 and EN ISO 1461.

Figure 2 Protection period of zinc coatings as a function of the thickness of the coat and the corrosive load

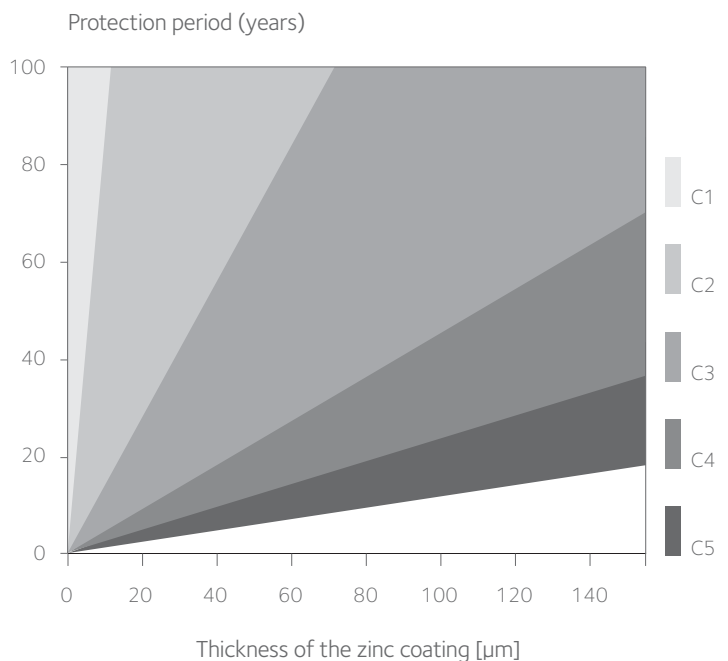

2. Corrosion protection methods



Cognac-Jay Foundation, Rueil-Malmaison, France



Architects: Jean Nouvel & Didier Brault - Photo: Philippe Ruault

When considering the corrosion protection of steel structures, a distinction is made between active and passive measures.

Active corrosion protection aims at preventing corrosion or reducing the rate of the corrosion reaction by:

- interfering in the corrosion process, e.g. reducing air pollution
- choosing a suitable material, e.g. using corrosion resistant materials
- using detailing appropriate for corrosion protection

The goal of passive corrosion protection is to shield the steel surface from corrosive substances.

Due to their broad range of application possibilities and their efficiency, the following methods dominate the corrosion protection of steel structures:

- coatings based on liquid or powder coatings
- metallic coatings (zinc, aluminum or zinc-/aluminum alloys) applied by hot-dip galvanization or thermal spraying
- combination of metallic coatings and paint systems

Optimal corrosion protection is achieved by combining active and passive corrosion protection methods, based on the appropriate detailing prior to the application of the passive corrosion protection.

In the following, the most efficient passive corrosion protection method for steel structures, namely hot-dip galvanizing, will be presented together with material-, design- and process-related requirements.

3. Hot-dip galvanizing





1. Method

Hot-dip galvanization is the application of zinc or iron/zinc alloy coatings by immersing the prepared steel in molten zinc.

A distinction must be made between:

- the continuous method (for sheets, wire rod, etc.),
- the discontinuous method (for sections, structural elements, and small parts).

Only the discontinuous method in accordance with EN ISO 1461 may be used for steel structures.

It is essential for hot-dip galvanizing, namely the iron-zinc reaction, that the steel surface to be galvanized shall be metallically clean, i.e. free from grease, rust and scale.

This high level of surface preparation – level B according to EN ISO 12944-4 – is achieved by first conditioning the material to be galvanized in acid or alkali degreasing baths, then pickling in diluted hydrochloric acid, followed by fluxing. When the part to be galvanized is immersed in the zinc bath (between 440° and 460°C), the flux, which is usually a mixture of zinc chloride and ammonium chloride, protects the metallic surface and improves its wettability as regards the molten zinc.

Zinc is the main component of the zinc bath, and the total amount of additional elements (with the exception of iron and tin) shall not exceed the sum of 1.5%.

The cleansed and fluxed part can be dried prior to galvanization in an oven at temperatures between 80° and 100°C.

During immersion in the zinc bath, layers of iron-zinc alloys build up on the surface of the steel element which are generally covered with a coat of pure zinc upon removal from the bath.

The speed of the iron-zinc reaction depends on the galvanizing parameters and the chemical composition of the steel, particularly its silicon and phosphorus content. "Reactive steels" build up thick layers of iron-zinc alloys and the residual heat in the galvanized material can even transform the pure zinc coat into a coat of iron-zinc alloy.

This reaction can be interrupted or slowed down considerably by an immediate quenching of the galvanized part in a water bath.

Figure 3 schematically represents the principle of the discontinuous galvanization process.

Figure 3 Principle of the discontinuous galvanization process

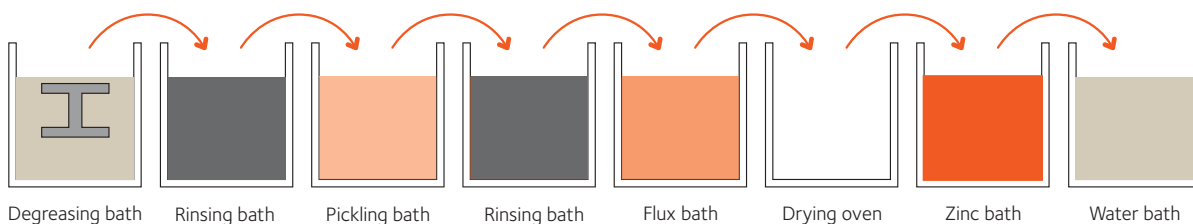

2. The iron-zinc reaction

Nowadays, the usual structural steels are basically all suitable for hot-dip galvanizing.

However, they possess individual characteristics which influence the result of the galvanizing process.

Hot-dip galvanizing is a reaction between the surface of steel and molten zinc which results in a zinc coating whose thickness and appearance are basically determined by the chemical composition of the steel and the galvanization parameters (zinc bath temperature, immersion time). The surface condition of the steel element may also influence the result of galvanization.

The behaviour of steels during galvanization can be divided into four groups on the basis of their Si and P contents (Table 2).

The steels of the ArcelorMittal long products are of the "Sebisty" type and have typically a silicon content of between 0.15% and 0.25%, and a phosphorous content of less than 0.040%.

There are overlaps between the groups, influenced by the temperature of the zinc bath. The iron-zinc reaction also depends on the topography of the steel's surface, especially when using steels in the transition range between the ones with a low Si and P content and the ones from the Sandelin group. This may result in local or widespread variations in the thickness and appearance of the zinc coat.

Similar appearances can also be caused by local thermal stresses at the surface of the steel, as happens during oxygen-cutting or flame straightening. Here, the cause is probably due to localised changes of the chemical composition in the heat affected zone close to the surface as a result of the oxidation of the so-called reactive elements in the steel (i.e. Si, P), which lose thus their influence on the iron-zinc reaction.

The variation in the galvanization behaviour of welds vs. adjacent steel surfaces is the result of differences in the chemical composition of the welding consumables and the base material. The zinc coating on grinded surfaces of welds may also be thicker or have a different appearance with regard to adjacent areas.

Generally, blast-cleaned surfaces, i.e. sand or shot blasted prior to galvanization, react faster on contact with molten zinc, resulting in thicker zinc layers when compared to steel surfaces that are simply pickled.

Unevenness and imperfections in the steel surface deriving from rolling, straightening and other processes are usually not smoothed out by the zinc coating, in most cases, they are even visually amplified.

Galvanizers have very few means at their disposal for influencing the quality of the zinc coating, which depends mainly on the chemical composition of the steel.

Theoretically, it is possible to influence the thickness of the zinc coat by controlling the immersion time, the chemical composition and the melting temperature of the zinc bath. As shown in Figure 4, there is however no consistent relationship between these parameters.

The thickness of the zinc coat increases with temperature up to a Si + P content of approximately 0.12%. Beyond this point, the relationship is reversed up to a Si + P content of $\pm 0.27\%$; in case of Sebisty steels, the thickness of the zinc coat decreases with an increase in the bath temperature. It then increases again with an increase in the melting temperature of the zinc from a Si + P content of approximately 0.27% and more.

Table 2 Classification of the galvanization behaviour of structural steels according to their silicon and phosphorus contents.

Group	silicon + phosphorous [%]	Zinc coating
1 Steel with low Si + P content	< 0.03	Silvery bright, zinc spangles, thin coat
2 Sandelin steels	0.03 ÷ < 0.13	Grey, sometimes granular, very thick coat
3 Sebisty steels	0.13 ÷ < 0.28	Silvery bright to pale grey, coat of average thickness coat
4 Steel with high Si + P content	≥ 0.28	Pale grey, very thick coat

This is the reason why EN ISO 1461 indicates only minimum values for the local and average thickness of the coat (Table 3) and does not provide any upper limits.

In practise, the galvanizer needs to know the chemical composition of the material to be galvanized in order to be able to adjust the immersion time and the temperature. For technical and cost effectiveness reasons however, the galvanizer only considers variations

in the temperature of the zinc bath for medium and long term periods.

In case special requirements are laid down for the thickness or the appearance of the zinc coat (e.g. a silvery bright zinc coating requested for architectural purposes) in addition to the quality requirements according to EN ISO 1461, it is important that particular care is given to the choice of homogenous materials, design, fabrication and to the composition of the zinc-

bath. It is essential that these aspects are discussed with the galvanizer.

It is possible to actively affect the iron-zinc reaction, i.e. eliminate, or at least reduce the effect from the chemical composition of the steel on the result of the galvanization process, by adding small amounts of Sn, Ni, Bi, and Al to the molten zinc. Resulting consequences will be discussed in the chapters 4 to 8.

Figure 4 Relationship between the thickness of the zinc coating, the Si + P content and the melting temperature of the zinc temperature for an immersion time of 10 minutes [4].

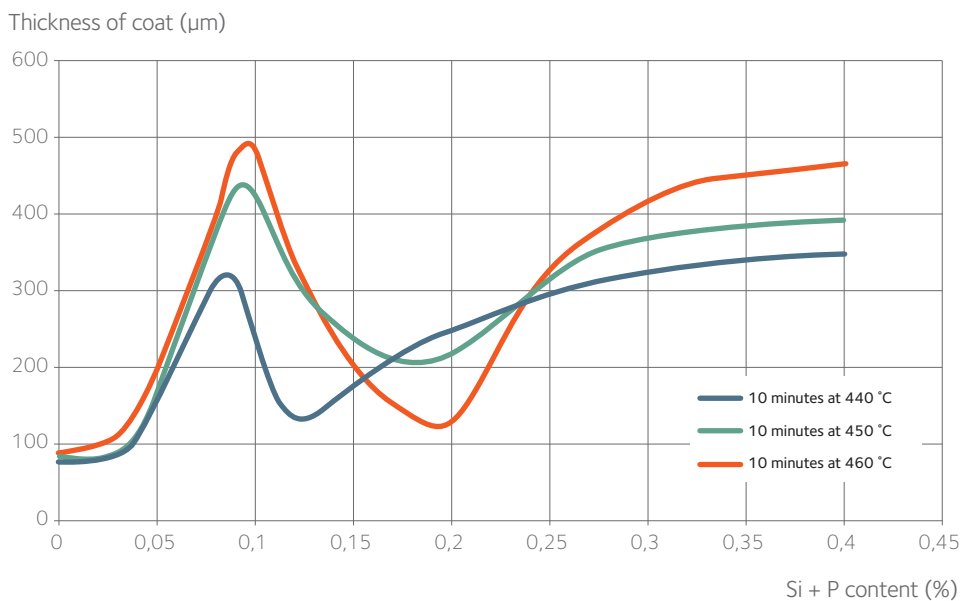

Table 3 Thickness of zinc coatings as a function of the thickness of the material according to EN ISO 1461

Material thickness	Local coat thickness (minimum value) [µm]	Average coat thickness (minimum value) [µm]
$t \geq 6$ mm	70	85
$t \geq 3$ mm and < 6 mm	55	70

3. Adhesion capacity of zinc coatings

In accordance with EN ISO 1461, adhesion between the zinc coating and the substrate does not normally need to be tested, because zinc coatings have adequate adherence for resisting mechanical impacts during normal handling operations and use without spalling or flaking off.

If adhesion needs to be checked, e.g. in the case of parts exposed to high mechanical stresses, impact or notch tests may be performed.

However, there is no European standard for the testing of adhesion.

The methods routinely employed, such as the cross-hatch test, ASTM hammer test (ASTM A 123) and the impact tests in accordance with DIN 50978, are restricted to a maximum coat thickness of approximately 150 μm , and provide only qualitative information. Moreover, these methods mainly assess the ductility and sensitivity to scaling of zinc coatings rather than their adhesion capability.

The modified test method used for organic coatings i.e. "Tear off test to assess adhesion capability in accordance with EN ISO 26624" [5] allows the adhesion of zinc coatings to be determined with statistical reliability up to 45 MPa.

These characteristic adhesion values indicate the tensile strength or uplift resistance of zinc coatings, which, in conjunction with the (adhesive or cohesive) failure patterns, enable the assessment of their adhesion capacity.

With the exception of Sebisty steels, measured average values for the adhesion of zinc coatings in accordance with EN ISO 1461 are generally greater than 20 MPa. The values for Sebisty steels vary from 10 to 18 MPa.

Appropriate tests have confirmed the indication given in EN ISO 1461 stating that undamaged zinc coatings have sufficient adhesion [6].



4. Repair of damaged zinc coatings

In accordance with EN ISO 1461, the imperfections in zinc coatings may not exceed 0.5% of the total surface of the building component. A single defect may not exceed 10 cm² and must be repaired in accordance with requirements.

The internal surfaces of inaccessible hollow structures are exempted from this requirement, because it is difficult or impossible to inspect and because of poor access for repair purposes.

The standard considers three repair methods:

- Thermal spraying with zinc
- Use of zinc-rich paint
- Solder with a zinc-alloy stick

The repair techniques are not ranked in any particular order.

Unless otherwise stipulated, the repair method is at the galvanizer's discretion.

The galvanizer shall advise the building owner or end-user of the repair method that has been used. Appropriate zinc powder-based systems are mainly used. Single component polyurethane/zinc powder-based primers are recommended, provided their suitability has been certified by the manufacturer. This repair method is practical, effective if implemented correctly, and reasonably priced.

The repair of imperfections using thermal zinc spraying (with or without subsequent sealing) is admittedly the most expensive and onerous repair method, but it does offer a protection period comparable to that of the original intact zinc coating. Its technical feasibility must be checked in advance, particularly with regard to the accessibility of the surfaces to be repaired. Also, the higher costs must be agreed beforehand.

Repair using zinc-rich paint is effective as well, but its quality very much depends on the preparation of the surface, the suitability of the paint itself, the correct application and the thickness of the coating.

The soldering repair technique with zinc alloy is relatively expensive and the result obtained is usually unsatisfactory. In particular soldering with tin, which is difficult to melt, gives poor results. This method is therefore disappearing from the market.

The particular characteristics of the repair method with respect to the application of subsequent coats must be taken into consideration. "Compatibility" between the repair coating and subsequent coats must be guaranteed. For powder coatings, stoving temperatures up to 200 °C have to be considered.

Before applying a repair coat, the affected surface must be cleaned and, if necessary, descaled. A high quality surface preparation can be obtained by manually grinding to a surface condition of P_{Ma} or by blasting to a surface condition of Sa 2½ or (EN ISO 12944-4). The requirements relating to surface roughness must be considered when selecting the repair method.

The coat thickness of the repaired area shall be at least 30 µm greater than the required local thickness of the zinc coating as given in Table 3.

According to this standard, defects in the zinc coating resulting from the interventions by third parties during fabrication or erection must be repaired in the same way. Zinc coatings have a better resistance against mechanical loads than organic paints. It is however technically impossible to completely avoid damages or a reduction of coat thickness in the areas where handling gear is applied, even if all necessary precautions are taken.

Defects with a surface area of more than 10 cm² may also result from modifications made to the galvanized structure or from mechanical loads generated during erection. If the defect can be repaired without compromising the effectiveness of the corrosion protection e.g. by thermal spraying with zinc, there is usually no need for the structure to be dismantled and regalvanized. Here, an equitable solution should be sought between the contracting parties.



Chamber of Commerce, Luxembourg

4. Characteristics of hot-dip galvanizing of steel structures

1. Preliminaries

Hot-dip galvanizing is a highly effective and cost-efficient corrosion protection method for steel structures.

The process-related specificities of hot-dip galvanization (surface preparation by pickling in acid, immersion of steel structures into a metal bath at $\pm 450^\circ\text{C}$, uneven heating during immersion) result however in higher technical requirements than with other corrosion protection methods with respect to:

- Steel quality and material characteristics
- Detailing, structural design
- Fabrication of the steel structures

All these points have to be taken into account by the contributing parties. As a matter of fact, an unfavourable combination of these aspects can result in the formation of cracks during hot-dip galvanization or during the treatment of the steel components in the aqueous solutions like degreasing, pickling and fluxing. The state-of-the-art considers today the zinc bath as the leading action in relation with the formation of fissures. Consequently, special attention has to be paid to highly reactive chemical compositions of the zinc bath as they increase the cracking potential.

Basically, a distinction has to be made between the liquid metal induced embrittlement (LME) and the hydrogen-induced cracking or expansion of cracks (hydrogen-induced corrosion) during the hot-dip galvanizing process.

Extensive metallographic investigations have shown that the cracking of usual structural steels during hot-dip galvanizing is due to LME. Hydrogen-induced cracking of structural steel structures during hot-dip galvanizing is much less likely to occur [7].

In order to fulfil the quality requirements of zinc coatings according to EN ISO 1461, a close collaboration between the steel manufacturer, the fabricator and the galvanizer is absolutely necessary, especially when dealing with steel constructions with a high degree of welding.

2. Hydrogen-induced cracking

On principle, the absorption of hydrogen into the metals occurs in the presence of a sufficient amount of hydrogen, e.g. during the steel production (blast furnace process, pickling), steel processing (welding) or during the pretreatment of the steel surface like degreasing, pickling, etc.

According to ISO 4964, the risk of hydrogen-induced cracking mainly exists with a local tensile strength $>1\,200\text{ N/mm}^2$, a hardness $>34\text{ HRC}$ or a surface hardness $>340\text{ HV}$. Notches, present in the microstructure of the surface, or material inhomogeneities increase the risk of damage.

Usual steel grades are typically not subjected to embrittlement through hydrogen absorption during pickling, even if hydrogen remains in the steel. In this case, the hydrogen escapes during the immersion process in the molten zinc.



Architects: Atlante Architectes - Photo: P. Rogeaux Carlier

3. Liquid metal-induced embrittlement (LME)

Preconditions for LME to arise are:

- sufficient static or dynamic tensile, bending or torsional stresses (load induced/ residual stresses)
- corrosive acting liquid metal
- solid metal vulnerable to LME
- critical temperature range
- mutual solubility of the involved metals
- good wettability of the solid metal by the molten metal
- formation of low melting intermetallic phases/compounds.

Given the above-mentioned conditions during the hot-dip galvanizing of steel structures, the characteristics of steel can be unfavourably affected by wetting grain boundaries close to the surface respectively surfaces in notches or cracks with a corrosive acting liquid metal, zinc and/or alloys of the zinc bath (for example lead (Pb), tin (Sn) or bismuth (Bi)).

Tensile stresses in the steel can no longer be transferred if:

- the deformation capacity (ductility) is impaired, see also Figure 6,
- the resistance against crack propagation is reduced.

When exceeding a critical stress level, the development of inter-crystalline fissures in the steel, ramified and branched out into the material, results in the cracking of the remaining section. The fissure tips are usually filled with zinc; in the case of "alloyed" zinc baths, additional concentrations of alloying elements may be present.

The order of magnitude of the critical stress, above which steel is vulnerable to cracking through LME in a zinc bath, is widely unknown at present. On the one hand this is due to the difficulty for defining and assessing the existing and acting stresses in the structural element and on the other hand it is due to the fact that stresses are generated through technological parameters during the galvanizing process, above all the dipping speed of the building components and the heat transfer from the zinc bath to the steel. Literature generally indicates that the susceptibility to LME increases with increasing hardness and resistance of the structural steels. Observations in this regard suggest that steel grades S275 and lower run a very low LME-risk, whereas those above S460 are clearly more at risk.

Today, there is a general believe that the potential risk of crack formation due to LME is substantially influenced by the chemical composition of the zinc bath, in particular the contents of lead (Pb), tin (Sn) and bismuth (Bi). Typical requirements on the maximum content of these 3 elements are given in chapter 8.

5. Requirements for materials



1. Chemical composition

The structural steels of ArcelorMittal's long products are produced in accordance with part 2 or 4 of EN 10025:2004 and the option of the "suitability for hot-dip zinc-coating" can be agreed upon for all the steel grades up to a yield strength of 460 MPa. It is clear here that this option merely applies to the influence of the chemical composition of the steels regarding the silicon (Si) and phosphorous (P) content on the thickness and appearance of the zinc coating.

The performance of the steels during hot-dip galvanizing with regard to LME is not addressed in the European standards.

In Japan, extensive tests have been conducted on the subject and a relation, similar to the carbon equivalent as an indication for the weldability, is proposed between the chemical composition of some Japanese steels and their LME risk potential,. [9] reports on this matter in the context of a contribution to the current state of knowledge regarding LME. Inquiries about the causes of cracks in steel structures in Europe, however, have lead to the conclusion that optimal chemical compositions of the steels alone according to the Japanese experience can not prevent LME when other factors favouring LME provoke a sufficiently critical state. On a general basis, it can nethertheless be stated that a low carbon equivalent tends to counteract LME.



Chamber of Commerce, Luxembourg

2. Mechanical properties of steel

The knowledge of the steel characteristics is essential when designing the steel building components suitable for hot-dip galvanizing.

The design for quasi-static loads is usually based on the yield stress R_e . This characteristic is determined with the tensile strength R_m , the Young's modulus of elasticity E , the total elongation at fracture A , the uniform elongation A_g and the reduction of area Z , in a monoaxial tensile test at ambient temperature at a gradual loading rate.

The stress-strain diagram, obtained from this tensile test, shows that substantial deformation occurs beyond the yield stress before rupture occurs. This means that fracture of building components is an indication that a large amount of deformation has taken place. This ductility has a major influence on the assessment of stress resistance, on the choice of the calculation method and statical system, as well as the application of the safety coefficients in steel structures. In order to avoid brittle fracture, steel needs to be sufficiently ductile.

The plastic deformation also reduces stress concentrations at notches or where residual stresses are present. For example, residual stresses (from welding or rolling processes) are either completely or partially disregarded when designing steel structures.

Building components made from a ductile material may also be used for "plastic design", which means that elongation of the steel beyond its yield stress is allowed.

Ductility however can vary considerably between steel grades, as shown in Figure 5.

Also, it is important to note that the deformation capacity of the steel is reduced during the hot-dip galvanizing process (Figure 6).

Heating steel lowers its yield stress, modulus of elasticity as well as its tensile strength.

The stress-temperature diagram in Figure 7 shows the typical reduction in yield stress for the 3 usual steel grades S 235, HSTAR 355 / S 355 and HSTAR 460 / S 460.

Hardness is another criterion used to assess strength. The hardness value is used, for example, for checking the uniformity of the strength of semi-finished products, and can be used for the approximate non-destructive determination of the tensile strength.

The advantages of steel grades with high elongation have already been mentioned.

In addition to total elongation A , uniform elongation A_g , and reduction of area Z , the notch impact energy K_V is an important criterion when assessing the toughness of a steel.

The toughness values may not be used as such for structural design purposes, they rather enable a qualitative comparison of various steels with regard to their toughness. Combined with the experience gained with steels whose stress resistance and toughness have already been determined, they enable an assessment of the risk of brittle fracture occurring in certain stress conditions (i.e. plane, three-dimensional or residual stresses, loads), at certain temperatures or in particular loading modes (slow or fast).

Figure 5 Typical stress - strain diagram for various steels

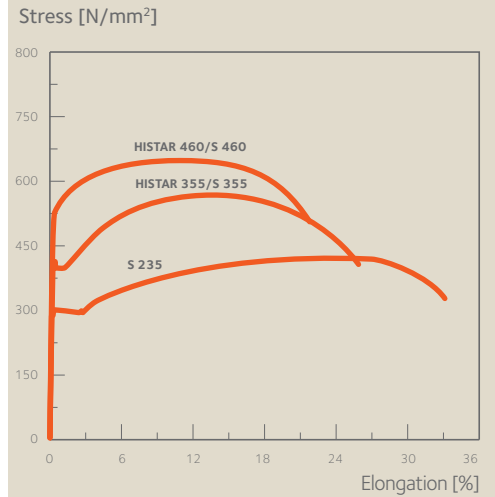
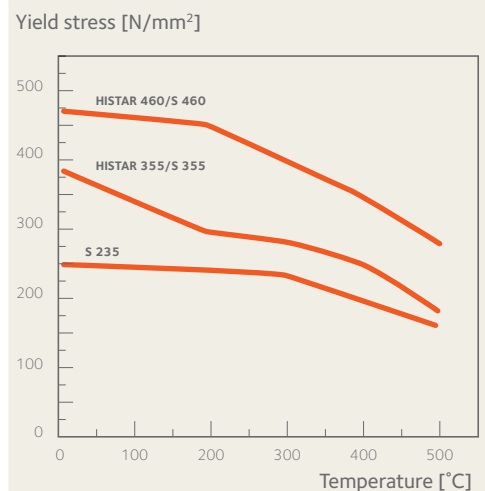

Figure 6 Schematic stress - strain diagram for structural steel S355 - comparison of the characteristics of S355 at room temperature (RT), at 460°C in the air, and during immersion in the zinc bath at 460°C



Figure 7 Typical yield stress - temperature diagram for various steels



The toughness of hot-rolled sections is measured in longitudinal rolling direction. Without any special measures, toughness values can be lower in transverse direction and perpendicular to the surface of the section. The reason for this deterioration is the presence of non-metallic deformable inclusions positioned parallel to the surface during the rolling process. Stresses occurring perpendicular to the surface (mainly in welded structures) combined with insufficient toughness can then lead to a loss of cohesion in the material similar to lamellar tearing. These inclusions can be modified or even eliminated using special steel making techniques. Thus, "Z-quality" steel is characterised by superior deformation properties in a plane perpendicular to the surface.

The limited possibilities for using the toughness values in the assessment of crack potential is due to the fact that the state of stress (plane or three-dimensional, residual) and the deformation conditions of the structure are widely unknown.

It is mainly high stress levels at the end of a surface or internal imperfections, residual stresses from fabrication, the temperature and the loading rate that influence the resistance to brittle fracture.

In order to better assess, from a quantitative point of view, the susceptibility of a steel to brittle fracture, "fracture resistance" is determined on the basis of the theory of fracture mechanics and special tests made on samples pre-notched by fatigue. Their condition is similar to the one of building components

affected by fissures. A critical temperature is thus obtained at specified stress levels. Below this critical temperature, a crack propagates rapidly resulting in the sudden fracture of the entire sample.

Specific steel production processes (e.g. the way of killing during casting) influence the toughness and susceptibility to lamellar tearing; the designation of the notch toughness shows different levels (for structural steels e.g. JR, JO, J2, M, ML, etc.).

A fine grain microstructure, such as the one of high strength fine grained structural steels, also enables susceptibility to brittle fracture to be reduced and weldability to be improved. The fine microstructure of these steels increases their yield strength without compromising their toughness.

3. Weldability

Structural steels are typically expected to possess a good weldability, which is usually the case. This means that the welding technique and filler materials must be selected in such a way that there is no deterioration in either the strength or the toughness in the heat affected zone and in the weld.

During the production process of the steels, the weldability can be improved by an increase of the purity level, through an improved control of the alloying elements as well as specific processes, like the controlled thermomechanical rolling and the quenching and self-tempering.



Grenoble Ice Rink, France

4. Information on materials for fabricating building components

Figure 5 shows that the various steel qualities have very high elongation capability. For design purposes, only a small part of this potential is used. The elongation capability of steel may be reduced due to material embrittlement, or generally due to local restrictions of deformability as a result of two or three dimensional (residual) stress states or through the presence of micro structural impurities in the steel. Exceeding the ductility limit obviously results in brittle fracture in the building component. Experience shows that several influences can occur simultaneously.

These are very complex phenomena and experimental results for the estimation of the toughness. Respectively the tendency for brittle fracture are subject to very large variations. Also, brittle fracture is greatly influenced by the fabrication processes (e.g. changes in the microstructure in a welded area if excessively cooled), the structural design (e.g. residual stresses) and the way in which the structure is used (e.g. the rate at which heavy loads are applied).

Obviously, welded building parts may be particularly affected by brittle fracture.

The presence of hydrogen in the weld or in the heat-affected zone, combined with residual stresses from welding, affects the susceptibility of steel to hot and cold cracking. Besides hot cracks during welding, cold cracks are to be expected if hydrogen from welding is present in the weld or heat-affected zone and when residual stresses from shrinking take effect. Here, hydrogen causes a reduction of the deformation capacity.

Taking into account these considerations is of utmost importance for the structural design process of steel structures foreseen for galvanization, as additional stresses during hot-dip galvanizing and simultaneously reduced yield stress and deformation capacities of the steels can lead to LME or hydrogen induced crack formation.

This type of brittle fracture during galvanizing can occur in any type of steel. As already indicated, susceptibility to fracture is especially influenced by tensile stresses (mainly residual stresses) in the building component.

5. Improving structural steels

Developments in structural steels are aimed at increasing their yield strength and weldability while keeping or even improving their toughness.

These improvements are achieved by eliminating inclusions, by improving the microstructure through the choice of alloying elements favouring finer grains, the replacement of ingot casting with continuous casting and the adoption of refined rolling processes like the thermomechanical rolling and the quenching and self-tempering.





6. Requirements of structures suitable for hot-dip galvanizing

1. General

The principles of the design of structures to be galvanized are similar to those for other steel structures provided that the specific demands for the hot-dip galvanizing process are taken into consideration.

Hot-dip galvanizing is a hot-immersion process whose stages – from surface preparation (degreasing, pickling, rinsing, and fluxing) to the galvanization process itself – take place in an industrial-sized installation (e.g. tanks and kettles) respectively in the zinc bath (440 ÷ 460°C). All the following specific demands of this procedure have to be taken into consideration at the design stage:

- Technical demands associated with the process
- Safety requirements
- Requirements imposed on the materials, design, and fabrication of building components to prevent deformations and cracks

Basic information on this subject can be found in ISO 1461 and in EN ISO 14713.

In addition, the shape of steel structures and their design as regards corrosion protection have a decisive influence on the effectiveness (protection period) and maintenance (accessibility) of the corrosion protection.

In this respect, the basic rules for the design of structures to be corrosion protected according to EN ISO 12944-3 are also applicable to galvanized structures.

2. Technical requirements associated with the process

2.1 Geometry of building components

The dimensions of building components that are to be galvanized shall be chosen in such a way that they can be immersed in a single operation.

It is therefore important for the designer to determine in advance the maximum dimensions of the available galvanizing tanks.

In the case of steel structures, the economically viable dimensions of tanks are as follows:

- Length: ± 7.00 ÷ 16.50 m
- Width: ± 1.30 ÷ 2.00 m
- Depth: ± 2.20 ÷ 3.50 m

For building components that can not be galvanized in one operation, (Figure 8 shows an example for double immersion), special measures have to be taken since the differential heating of the building component increases the risk of deformation and/or cracking (see also paragraph 6.2.4). In this situation, prior discussions should be held with the galvanizer.

Figure 8 Example of double immersion

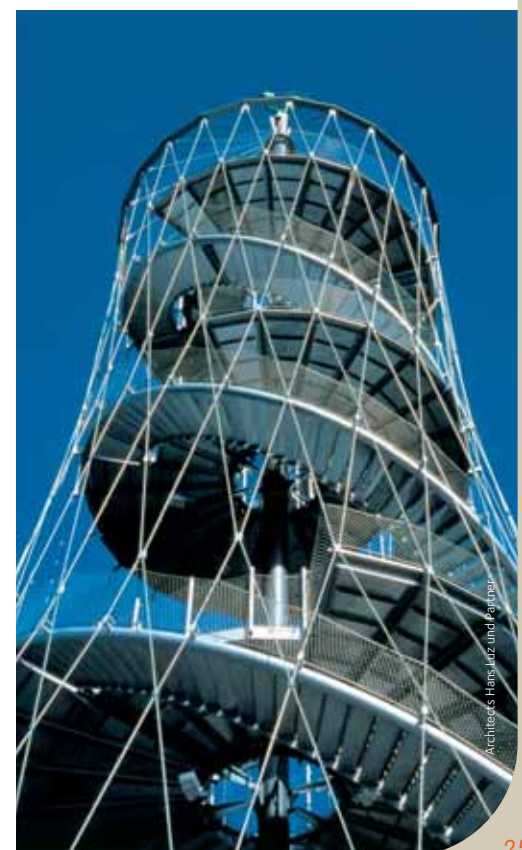
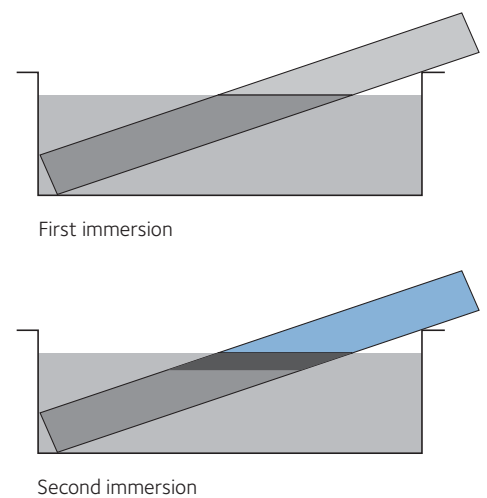

2.2 Vent holes, run-off openings, ventilation openings

In order to ensure that the surface is correctly pre-treated and high quality galvanization is achieved, building components must be designed in such a way that the pre-treatment liquids and especially the molten zinc are in contact with all the surfaces, and that they can freely run off when the part is removed from the bath.

Air pockets and air inclusions lead to uncoated areas; constructional measures must therefore be employed to prevent their formation.

This does not only apply to structures made from hollow sections and tanks, but also to structures comprising stiffeners, partition plates and endplates, etc. in which air pockets may form during immersion if appropriate vent holes are not incorporated.

The sizes of the run-off openings and vent holes depend on the quantity of zinc that must flow through. The immersion velocity is an important parameter for reducing the risk potential of steel constructions with regard to LME. Further details will be discussed in chapter 8. It has been experimentally determined that the susceptibility to LME decreases with an increase in immersion velocity. An ideal immersion velocity would be approximately 5 m/min [11].

Figure 9 shows examples of vent holes, Figure 10 examples of run-off openings. In the case of sections up to 300 mm high, l_1 must be ≥ 20 mm, in the case of sections over 300 mm high, l_1 must be ≥ 30 mm. In order to achieve the ideal immersion velocity for LME-critical steel constructions, it is necessary to coordinate the design of the vent holes with the fabricator and the galvanizer.

The run-off openings for the connection of girders, base plates, corners of portal frames, etc. must have a diameter between 10 mm and approx. 35 mm. Examples can be found in Figure 10.

Figure 9 Examples of vent holes

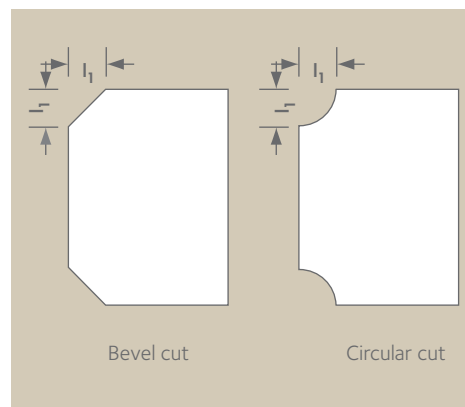
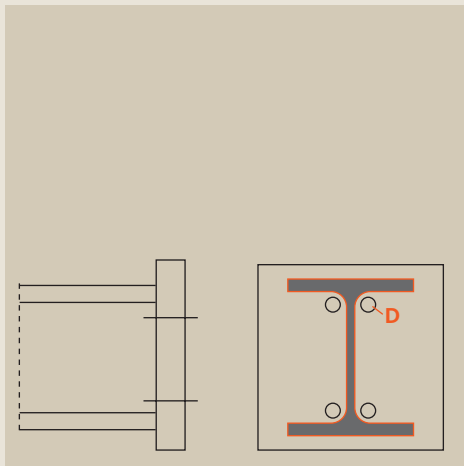
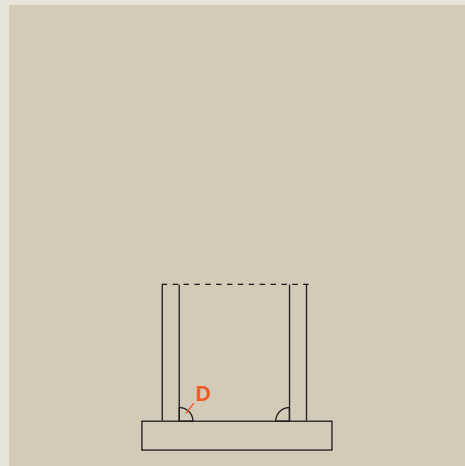

Figure 10 Examples of run-off openings

Girder assembly



Base plate



Node of portal frame

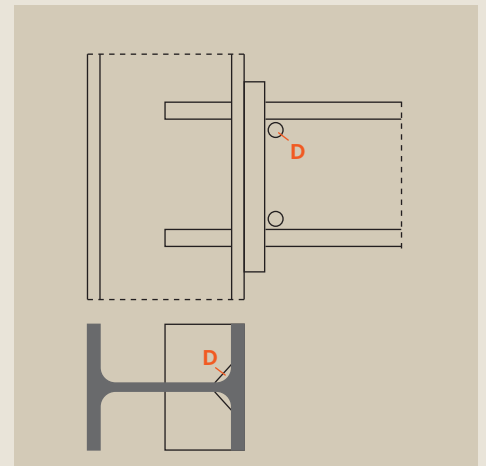

2.3 Safety issues associated with the process

At the temperature of molten zinc (440 – 460 °C) the moisture contained in air pockets (hollow parts, overlapping areas closed by welds) generates pressurized water vapour creating an explosion risk. Liquids from the pre-treatment process can also seep into overlapping surfaces if these are not perfectly sealed, and evaporate explosively when immersed in the zinc bath.

Overlapping surfaces should be avoided not only for safety reasons, but also for corrosion protection purposes. Table 4 provides some suggestions, should overlapping surfaces be unavoidable.

The drilling of holes in large overlapping surfaces definitely reduces the danger of explosion during galvanization but it also reduces the efficiency of the corrosion protection of the structure. Indeed, infiltrated pre-treatment solutions do not completely evaporate, leaving traces of salt in gaps. In many cases, the zinc coat will not completely cover the gaps after evaporation of the liquids, resulting in corrosion occurring in these parts of the structure.

Table 4 Recommended maximum sizes of overlapping surfaces

Maximum overlapping surfaces	Measures
Up to 100 cm ² (for product thicknesses < 12mm)	Seal weld circumference
Up to 400 cm ² (for product thicknesses ≥ 12mm)	Seal weld circumference



2.4 Information on detailing suitable for galvanization

The design and detailing of steel building components must satisfy the basic principles for the design of structures requiring corrosion protection, and in particular, of hot-dip galvanization. This is the only way in which adequate corrosion protection comprising satisfactory thickness of zinc layers can be ensured, along with the elimination of the potential risk of structural deformation, cracks or any other damage to the building components. Consultation with the galvanizer must be sought as early as possible in the design process for galvanized steel components.

Potential problems during hot-dip galvanization of steel components may be solved by implementation of the following constructional and technological measures:

- Already at the planning stage, the fabricator must try to minimise residual stresses generated during fabrication, particularly from welding. Here, appropriate welding procedures are helpful. With increasing thicknesses of building components, the risk of three-dimensional stresses, faster cooling rates and hence the risk of cracking increases.
- Strict compliance with requirements as regards the design of structures intended for hot-dip galvanization, especially when using high strength steels with a low notch toughness. The amount of vent holes and drainage holes must be minimised. Also, inappropriate fabrication will increase the risk of cracking. It is recommended to seek agreement with the galvanizer.

- The ratio of plate thicknesses welded directly together should not exceed a factor of 2.5. With increasing thicknesses of the steel parts and for elements with a high degree of welding, the ratio should even be smaller.
- The use of highly restrained building components susceptible of generating internal stresses during the galvanizing process should be avoided.
- The actual characteristics and the chemical composition of the material to be galvanized must be identified prior to galvanization. The galvanizer must be advised about the nature of the steels used for the sections to be galvanized.
- Multiple immersions must be avoided.

The following table shows a selection of structural details which have to be considered as critical with regard to LME during hot-dip galvanization.

Table 5 Structural details and fabrication recommendations

Nr	Structural detail	Description
1		Welding of "half end plates" induces a concentration of residual stresses in the area indicated. Recommendation: arrange the end plate over the full height of the section or use a bolted connection.
2		Welding of the plate induces a concentration of residual stresses in the area indicated. Recommendation: perform stress relief annealing in the areas indicated, and/or round off.
3		Welding induces concentrations of residual stresses at the four corners of the hollow section. Recommendation: perform stress relief annealing in the areas indicated.

6. Requirements of structures suitable for hot-dip galvanizing

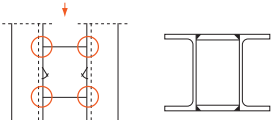
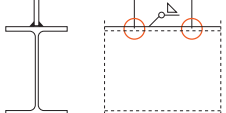
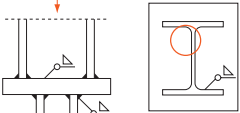
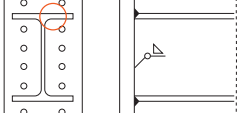
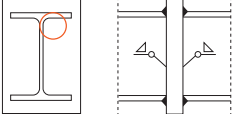
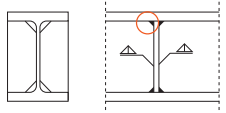
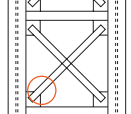
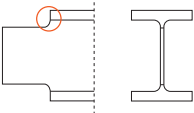
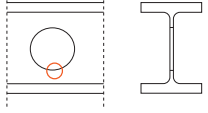
Nr	Structural detail	Description
4		<p>Welding induces concentrations of residual stresses at the four corners of the connection plate. Recommendation: perform stress relief annealing in the areas indicated.</p>
5		<p>Welding induces concentrations of residual stresses at the ends of the plate. Recommendation: perform stress relief annealing in the areas indicated.</p>
6		<p>The differences in stiffness between the section, the thick base plate, and welds induce concentrations of residual stresses. Recommendation: perform stress relief annealing in the area of the welds .</p>
7		<p>The differences in stiffness between the section and the endplate and welds induce concentrations of residual straining. Hardening at the edges of the bolt holes may also occur. Recommendations: perform stress relief annealing in the area of the welds, carefully drill bolt holes.</p>
8		<p>The differences in stiffness between the section and the endplate and welds induce residual stresses. Recommendation: perform stress relief annealing in the area of the welds.</p>
9		<p>The welding of stiffeners between the flanges of the section induces residual stresses. Recommendation: perform stress relief annealing in the area of the welds.</p>
10		<p>The system is internally highly restrained. The inevitable differences in temperature to which building components are heated lead to high residual stresses. Recommendation: bolt the diagonals to the chords after galvanization.</p>
11		<p>Inappropriate execution of the rounded areas may result in hardening and the creation of notches. Recommendation: round-off carefully, perform stress relief annealing in the fabricated areas.</p>
12		<p>Inappropriate execution of openings may result in hardening and the creation of notches. Recommendation: round-off carefully, perform stress relief annealing in the fabricated area.</p>

Shopping Center "4 temps", Paris, France



7. Requirements for the fabrication of steel structures

1. Residual stresses in building components

Cracks from hot-dip galvanizing of steel constructions are often generated in places with high residual stresses (tensile stresses), notches and/or hardness increases due to fabrication processes such as

- welding
- oxygen cutting
- grinding
- drilling
- punching
- cold forming (ageing)
- straightening

Residual stresses are also created in restrained components in the zinc bath. The heat during galvanization ($\pm 450^{\circ}\text{C}$) modifies both the state of internal stresses and the mechanical characteristics of the steel (reduction of yield stress and modulus of elasticity), thereby reducing the resistance of the building components to elastic deformation. Stresses, mainly localised, can decrease but also increase and deformations may occur.

The difficulty lies, however, in determining the magnitude of residual stresses, which in practice can only be roughly estimated. The many factors, influenced by fabrication and detailing, cannot be determined with sufficient accuracy either qualitatively or quantitatively. Structural engineers are usually unaware of the real amount of residual stresses in the structure.

The plastic deformation capabilities of structural steels generally allow to disregard the accurate determination of residual stresses as they are mostly localised and tend to disappear through plastification when superposed with stresses from exterior loads. It is of course of outmost importance here that the appropriate steel is chosen with respect to toughness, taking

into account the dimensions of the building component and the application temperature (see prEN 1993-1-10). With components that are to be hot-dip galvanized, special care must be taken to minimise residual stresses. This is usually achieved using constructional measures, in order to avoid any subsequent stress relieving before galvanizing.

Fabrication also allows to prevent high residual stresses and hardness increases by

- using multi-layer fillet welds, which could be welded in a single run with the current state of welding techniques
- establishing a welding procedure
- avoiding long and thick welds
- avoiding cold deformation or reducing the created residual stresses through heat treatment (keeping in mind however that not all the effects of cold forming can be cancelled out)

- removing notches or restricting their presence especially in thin building parts of welded constructions and areas subject to changes in microstructure from cold forming, welding, oxygen cutting, drilling, punching, etc.

2. Surface condition of rolled long products

Unless otherwise specified in the order, the surfaces of hot rolled sections for hot-dip galvanization shall normally conform to the basic requirements of EN 10163-3:1991, class C, subsection 1.

The surfaces to be galvanized must be de-greased and any discontinuities that could compromise the corrosion protection properties of the zinc coat must be removed before galvanization.



A photograph of a modern, multi-story car park in Rheda-Wiedenbrunn, Germany. The building features a prominent facade of vertical white metal rods and horizontal mesh panels. The structure is partially obscured by lush green trees in the foreground. The sky is overcast with grey clouds. The building's design is a combination of concrete, metal, and glass, with a green roof visible on the right side.

Rheda Wiederbrück Car Park, Germany

8. Requirements for hot-dip Galvanizing

As seen in paragraph 4.3, the presence of a corrosive acting liquid metal in contact with a solid metal prone to liquid metal embrittlement is the precondition for crack formation in steels due to LME. This prerequisite is inevitably given for hot-dip galvanizing (liquid metal = zinc bath, solid metal = steel), as this is the only way that the zinc coat can be produced.

Similar to the requirements for the steel production, for the structural design and for the fabrication of steel structures (in particular for minimising residual stresses), specific measures have to be taken in the hot-dip galvanizing process to keep the risk of hydrogen-induced cracking and LME as low as possible.

Extensive investigations [9, 12, 13] have shown that during hot-dip galvanizing, the temperature gradient resulting from the immersion of structural elements into the zinc bath and its time-related variation during dipping is an important process parameter in view of LME. Here, the risk potential for LME is small for a low temperature gradient [14].

The heat transfer coefficient and the wetting ability of zinc baths increase with high concentrations of alloys, especially tin (Sn), lead (Pb) and bismuth (Bi) thereby reducing the heating time and consequently increasing the risk of LME.

Based on the above mentioned findings, investigations were conducted in order to lower the temperature gradient by modifying process parameters of hot-dip galvanizing [11].

The temperature gradient can be reduced by

- optimizing the chemical composition of the zinc bath, especially with respect to Sn, Pb and Bi,
- increasing the immersion velocity (approx. 5 m/min)
- increasing the dipping angle
- increasing the salt concentration in the flux (approx 500 g/l)
- adjusting the drying temperature after fluxing to 100°C, to ensure a high temperature of the building components prior to dipping in the zinc bath

- keeping the temperature of the zinc bath as low as possible to minimise the temperature difference between the building part and the zinc bath.

Recent research results define a new state-of-the-art. Nowadays, it can be assumed that contents of tin up to 0.1% and/or bismuth up to 0.1% do not detrimentally influence LME. Herewith, the content of lead should be limited to 0.8%.

It must however be noted here that both the classical zinc bath and the one modified as described above can be LME-critical, especially if the LME-critical requirements for the quality of material, design and fabrication (see paragraphs 5 to 7) are not met.





9. Duplex systems

Many architects use hot-dip galvanized steel structures because of their aesthetic qualities.

In addition, the use of liquid or powder paints on top of the zinc coat, the well-known “duplex-system”, has become very popular over the last few years.

Duplex systems have advantages when the following aspects are important:

- long protection period
Duplex systems have a service life 1.2 to 1.5 times higher than the combined protection periods of the hot-dip galvanization and paint coats (synergy effect).
- large choice of colours
- need for signalling / identification / camouflage
- no or reduced release of zinc into the environment

At least the first coat of the paint system should be applied in the workshop, if possible immediately after hot-dip galvanization thereby rendering expensive surface preparation on the construction site unnecessary.

High quality duplex systems require optimal compatibility between the galvanizing coat and the paint.

The choice of suitable coating materials is of particular importance. Only coating systems with proven compatibility with batch galvanization in accordance with EN ISO 1461 shall be used.

The requirements for surface preparation / pre-treatment depend on the nature of the coating material.

Zinc surfaces designed to be powder-coated must be swept, phosphated or chromated immediately prior to coating.

In the case of liquid paints, current technology only requires the surface of the zinc coat to be swept when large amounts of zinc corrosion products (white rust) on the surface compromise adhesion, or in function of the corrosion exposure categories as per the specifications of the coat manufacturer.

The purpose of sweep blasting is simply to clean and rough the surface of the coats. Sweeping exerts great mechanical stress on zinc coatings and may, if poorly executed, damage them (i.e. cause cracks, flaking).

The optimal parameters for sweeping are [15]:

- abrasive: non-metallic slags, aluminous abrasive, or glass beads
- particle size of the abrasive grit: 0.25 - 0.50 mm

- jet pressure at the nozzle: 2.5 ÷ 3.0 bars
- jet angle : <30° (take the geometry of the building component into account)

Detailed information on duplex systems involving liquid and powder coatings can be found in reference [16].

Shopping Center "4 temps", Paris, France



10. Cost effectiveness

Hot-dip galvanization of structural steel components exposed to atmospheric conditions constitutes a highly effective durable corrosion protection method. In many applications, the corrosion protection lasts as long as the structure itself. Zinc coatings require no or almost no maintenance. Hot-dip galvanizing, in terms of lifetime of the structures, including maintenance and repair costs, is by far the most cost-efficient corrosion protection system available for steel structures.

Contrary to the prevailing view that hot-dip galvanization only becomes cost-effective over time, it now offers substantial cost savings when compared to other protection systems on many types of structures, right from the very beginning. Studies have shown that, beyond a specific surface area of 15 to 20 m²/t, the initial costs of hot-dip galvanizing are lower than those of a three-coat paint system [17].

Architects and designers should more than ever be aware of this fact when selecting a corrosion protection system.

Where hot-dip galvanizing cannot meet more stringent appearance requirements, a simple duplex system e.g. a coat of zinc and one coat of paint that does not need sweeping, is worth considering.

In any case, it is useful to perform a cost-comparison of the various options before selecting the appropriate corrosion protection system.



Bouillon Car Park, Luxembourg

References

1. Bibliography

- [1] Dr.-Ing. D. Knotkova
Aktuelle Erkenntnisse zum
Korrosionsverhalten von Zink und
Zinküberzügen
Vortrag 4. Deutscher Verzinkertag
1995 Köln
- [2] Dr.-Ing. Knotkova und F. Porter
Longer life of galvanized steel in the
atmosphere due to reduced SO₂-pollution
in Europe
Proc. of Intergalva 1994, Paris
- [3] F. von Assche
Atmospheric conditions and hot dip
galvanizing performance
Proc. Intergalva 1997, Birmingham,
EGGA UK
- [4] Katzung, W. und Mitarb.
Zum Einfluss von Si und P auf das
Verzinkungsverhalten von Baustählen
Mat.-wiss. u. Werkstofftech.
28, 575 – 587 (1997)
- [5] Katzung, W. und Mitarbeiter; FuE-Bericht
Institut für Stahlbau Leipzig GmbH,
Arno-Nitzsche-Str. 45, D-04277 Leipzig
(unveröffentlicht)
- [6] Katzung, W.; Rittig, R.; Schubert, P. und
Schulz, W. D.
Zum Einfluss von Abkühlverlauf und
Tauchdauer auf die Haftfestigkeit und das
Bruchverhalten von Zinküberzügen nach
DIN EN ISO 1461
Mat.-wiss. und Werkstofftechnik 32,
483-492 (2001)
- [7] Katzung, W. und Schulz, W. D.
On hot-dip galvanizing of steel
constructions – Causes and solution
proposals referring to cracking
- [8] Pargeter, R.
Liquid metal penetration during hot-dip
galvanizing
Published: TWI Website
- [9] Kinstler, Thomas J.
Current Knowledge of the Cracking of
Steels During Galvanizing
GalvaScience LLC, PO Box 501, Springville,
AL 35146
- [10] Kikuchi, M.
Liquid Metal Embrittlement of Steels
during Hot Dip Galvanizing
Tetsu to Hagane, Iron and Steel, Volume
68, Number 14, 1982,
Pages 1870-1879
- [11] Pankert, R., Dhaussey, D., Beguin, P., Gilles, M.
Three Years Experience with the
Galveco Alloy
Proceedings Twentieth International
Galvanizing Conference
Amsterdam, 2003, European General
Galvanizers Association
- [12] Interpretation zinc assisted cracking on
big scale steel structures and preventive
methods. 2001, referiert in ILZRO
Project ZC – 21 – 2.
- [13] Poag, G., Zervoudis, J.
Influence of various parameters on steel
cracking.
AGA Tech Forum, Oct. 8. 2003. Kansas
City, Missouri.
- [14] Pinger, T.
Avoidance of liquid metal induced
embrittlement of galvanized steel
constructions
- [15] Schulz, W. D.; Schubert, P.; Katzung, W.;
Rittig, R.
Correct sweeping of hot-dip galvanized
parts according to DIN EN ISO 1461),
Der Maler- und Lackierer-meister 7/99
- [16] Verbände-Richtlinie Korrosions-schutz von
Stahlbauten – Duplex-Systeme
Herausgegeben von Bundesverband
Korrosionsschutz e.V., Köln
Deutscher Stahlbauverband e. V.,
Düsseldorf
Industrieverband Feuerverzinken e. V.,
Düsseldorf
Verband der Lackindustrie e. V., Frankfurt
- [17] Dipl.-Ing. P. Kleingarn
Cost-effective and reliable corrosion
protection using hot-dip galvanizing),
Feuer-verzinken (28 th year) n° 3,
September 1999

2. Standards and further reading

- EN ISO 1461 : 1999
Hot-dip galvanized coatings on fabricated iron and steel articles
- Katzung, W. und Marberg, D.
Beuth-Kommentare
Korrosionsschutz durch Feuerverzinken auf Stahl aufgebrachte Zinküberzüge (Stückverzinken), Kommentar zu DIN EN ISO 1461 (2002)
- EN ISO 14713: 1999
Protection against corrosion of iron and steel in structures – Zinc and aluminium coatings – Guidelines
- EN ISO 12944-1-8 : 1998
Corrosion protection of steel structures by protective paint systems
- DIN 267, PART 10
Mechanical assembly components – Technical delivery conditions – Galvanized parts
- EN 10025 : 2004
Hot rolled products from structural steels
- EN 1993-1-10
Design of steel structures – Selection of materials
- DASt Guideline 009
Selection of steel grades for welded steel structures
- Korrosionsschutz durch Feuerverzinken (Stückverzinken)
Corrosion protection by hot-dip galvanizing – batch galvanizing
Institut Feuerverzinken GmbH,
Sohnstraße 70, D-40237 Düsseldorf
- Maaß, P. und Peißker, P.
Hot-dip galvanization manual
Deutscher Verlag für Grundstoffindustrie
Leipzig, Stuttgart 1993
- Arbeitsblätter Feuerverzinken
Technical sheets for hot-dip galvanizing
Institut Feuerverzinken GmbH, Sohnstraße 70, D-40237 Düsseldorf

Technical advisory & Finishing

Technical advisory

We are happy to provide free technical advice to optimise the use of our products and solutions in your projects and to answer your questions about the use of sections and merchant bars.

This technical advice covers the design of structural elements, construction details, surface protection, fire safety, metallurgy and welding.

Our specialists are ready to support your initiatives anywhere in the world.

To facilitate the design of your projects, we also offer software and technical documentation that you can consult or download from our website:

sections.arcelormittal.com

contact: sections.tecom@arcelormittal.com

Finishing

As a complement to the technical capacities of our partners, we are equipped with high-performance finishing tools and offer a wide range of services, such as:

- drilling
- flame cutting
- T cut-outs
- notching
- cambering
- curving
- straightening
- cold sawing to exact length
- welding and fitting of studs
- shot and sand blasting
- surface treatment

Construction

At ArcelorMittal we also have a team of multi-product professionals specialising in the construction market.

A complete range of products and solutions dedicated to construction in all its forms: structures, façades, roofing, etc. is available from the website

www.constructalia.com

Your partners

ArcelorMittal
Commercial Sections
66, rue de Luxembourg
L-4221 Esch-sur-Alzette
Luxembourg
Tel: +352 5313 3010
Fax: +352 5313 2799

sections.arcelormittal.com

We operate in more than 60 countries on all five continents. Please have a look at our website under "About us" to find our local agency in your country.

Notes

A series of horizontal dotted lines for writing notes.

ArcelorMittal
Commercial Sections

66, rue de Luxembourg
L-4221 Esch-sur-Alzette
LUXEMBOURG
Tel.: + 352 5313 3010
Fax: + 352 5313 2799

sections.arcelormittal.com



Mixed Sources

Product group from well-managed
forests, and other controlled sources
www.fsc.org Cert no. EUR-COC-051203
© 1996 Forest Stewardship Council