



**Guideline for Hot-Dip Galvanised  
Components in Steel and Composite  
Bridge Constructions**

## Impressum

Guideline for Hot-Dip Galvanised Components  
in Steel and Composite Bridge Constructions  
No. B 505 a

Publisher:

bauforumstahl e.V. | Sohnstraße 65 | 40237 Düsseldorf  
Postfach 104842 | 40039 Düsseldorf  
T: +49 (0)211.6707.828 | F: +49 (0)211.6707.829  
zentrale@bauforumstahl.de | www.bauforumstahl.de  
www.facebook.com/bauforumstahl

Copyright © September 2016 bauforumstahl e.V.

All rights are reserved. Reproduction of this publication- also in part - is only permitted with the written permission of the publisher and with a clear reference to the source.

The greatest possible care was exercised when compiling all of the texts, formulae, figures, drawings and tables. Nevertheless, mistakes cannot be ruled out completely.

bauforumstahl cannot accept responsibility for faulty information and its consequences. No legal claims can therefore be accepted for use of the data provided. We are always grateful for suggestions and proposals for improvement.

Authors:

Prof. Dr.-Ing. D. Ungermann, Dipl.-Ing. D. Rademacher, Dr.-Ing. Th. Pinger and Dr.-Ing. O. Hechler.

## Acknowledgement

This brochure contains research findings from IGF Project 351/ZBG carried out by Forschungsvereinigung Stahlanwendung e.V. (FOSTA) in cooperation with Gemeinschaftsausschuss Verzinken e.V. (GAV) and Deutscher Ausschuss für Stahlbau (DAST). It was subsidized by the German Federation of Industrial Research Associations (AiF) as part of the IGF programme of the Federal Ministry for Economic Affairs and Energy to promote joint industrial research, which is based on a resolution passed by the German Bundestag. The work was carried out by three research facilities: Lehrstuhl Stahlbau of TU Dortmund University, Materialprüfungsanstalt (MPA) of Technischen Universität Darmstadt and Institut für Korrosionsschutz Dresden GmbH (IKS). The AiF awarded the research project the Otto von Guericke Prize in 2014 for outstanding achievements in the field of joint industrial research (IGF). We would like to take this opportunity to express our sincere thanks to the above-mentioned research centres and institutions.

bauen im **wertstoffkreislauf 3R**  
reduce reuse recycle bauen im  
**wertstoffkreislauf 3R** reduce re



## Table of contents

0	<b>Preface</b>	Page 6
<hr/>		
1	<b>Motivation</b>	Page 7
<hr/>		
2	<b>Conceptual design</b>	Page 7
2.1	Basics of conceptual design	Page 7
2.2	General requirements for corrosion protection of bridge structures	Page 8
2.3	Composite bridges with galvanised main girders	Page 9
2.3.1	General	Page 9
2.3.2	Fabrication, transport and erection	Page 10
<hr/>		
3	<b>Durability of batch-galvanised components</b>	Page 10
3.1	Basic principles of batch galvanising	Page 10
3.2	Characteristics of the zinc layer	Page 11
3.3	Design of the corrosion protection	Page 12
3.4	Repair of zinc layers	Page 13
3.4.1	General	Page 13
3.4.2	Surface preparation	Page 14
3.4.3	Spray metallising	Page 14
3.4.4	Pore-sealing treatment	Page 14
3.5	Duplex systems	Page 14
3.6	Contact with concrete	Page 15
<hr/>		
4	<b>Basics of galvanising-specific design and construction</b>	Page 15
4.1	General	Page 15
4.2	Normative regulations	Page 16
4.3	Design-relevant features of galvanising	Page 16
4.4	Construction-relevant features of galvanising	Page 16
4.4.1	Fundamental aspects	Page 16
4.4.2	Basic principles of hot-dip galvanising friendly design	Page 17
4.4.3	Avoidance of distortion due to internal stresses	Page 18
4.4.4	Avoidance of distortion due to differing cooling behaviour	Page 18
4.5	Material selection	Page 19
4.6	Transport	Page 19
<hr/>		

<b>5</b>	<b>General information on concept, design and construction</b>	Page 20
5.1	Verification of load-carrying capacity and serviceability limit state	Page 20
5.2	Design of bolted connections for hot-dip galvanised components	Page 20
5.3	Verifications of fatigue resistance	Page 22
<hr/>		
<b>6</b>	<b>Configuration of details for galvanised steel and composite bridges</b>	Page 24
6.1	General	Page 24
6.2	General information on loading-resistant configuration of details for galvanising	Page 24
6.3	Standard details of composite bridges with small or medium spans	Page 25
6.3.1	Steel cross-beams on end supports and intermediate supports	Page 25
6.3.1.1	Welded connection of an I-beam to a support	Page 25
6.3.1.2	Bolted connection of an I-beam to a support	Page 26
6.3.2	Concrete cross-beam on end support	Page 28
6.3.3	Concrete cross-beam on intermediate supports	Page 30
6.3.4	Steel cross-beams within span	Page 32
6.3.4.1	General	Page 32
6.3.4.2	Bolted connection of an I-beam with T-rib within span	Page 33
6.3.4.3	Bolted connection of an I- or a U-beam to stiffening plate within span	Page 33
6.3.4.4	Welded connection of an I- or a U-beam to stiffening plate within span	Page 34
6.3.4.5	Direct bolted connection of I-beam to web of main girder	Page 35
6.3.4.6	Welded connection of I-beam directly to web of main girder	Page 36
<hr/>		
<b>7</b>	<b>Execution of galvanising-specific site-joint details</b>	Page 36
7.1	General preliminary considerations	Page 36
7.2	Detail of welded butt joint	Page 36
7.2.1	Installation process and configuration of detail	Page 36
7.2.2	Application of corrosion protection to welded joint	Page 38
7.2.3	Samples	Page 39
7.3	Detail bolted strapped connection	Page 39
<hr/>		
<b>8</b>	<b>Examination, monitoring, quality assurance</b>	Page 40
8.1	Examination of steel construction	Page 40
8.2	Examination of zinc layer thickness	Page 40
8.3	Quality assurance of the spray metallising	Page 41
<hr/>		

<b>9</b>	<b>Economic considerations</b>	Page 42
9.1	General	Page 42
9.2	Effects of reduction in detail notch category	Page 42
9.3	Sources of cost	Page 43
9.4	Cost of corrosion protection for service life of 100 years	Page 44
.....		
<b>10</b>	<b>Sustainability assessment</b>	Page 46
10.1	General information on galvanising	Page 46
10.2	Sustainability assessment	Page 46
10.2.1	TU Berlin study	Page 46
10.2.2	BASt study	Page 47
10.3	Environmental product declaration (EPD)	Page 48
.....		
<b>11</b>	<b>Summary</b>	Page 50
.....		
<b>12</b>	<b>References and documents</b>	Page 51
.....		

## 0 | Foreword

Steel and steel-composite bridges are important elements of the transport infrastructure. The benefits of steel in bridge construction come to the fore above all if particular challenges have to be mastered, such as large spans, small overall heights or short construction periods. More recent research findings show that using steel as a construction material allows sustainable and – when the entire life cycle is considered – cost-efficient composite bridges to be built for small and medium spans as well. However, steel components have to be protected against corrosion in order to guarantee an adequate service life. Therefore, organic coatings and hot-dip galvanising have proven to be suitable measures.

With regards to federal roads, the use of hot-dip galvanised components in bridge and civil engineering constructions has so far been restricted to gantries and bridge fixtures such as balustrades. Based on the latest scientific and technical knowledge the use of hot-dip galvanised steel girders under cyclic loading has come within easy reach. On a scientific level, extensive testing of the effect of hot-dip galvanising on fatigue resistance was used to prepare the foundation for verification of fatigue safety. On a technical level, numerous large galvanising plants have expanded their capacity and now have dipping baths and hoists for steel components of dimensions relevant to bridges.

The first composite bridge with a hot-dip galvanised steel construction over a federal trunk road is being built as part of the new A 44 autobahn from Kassel to Herleshausen. It is planned to complete the work by the summer of 2016. The bridge is a single-span integral construction with a span of 40 m to carry a farm road. This document was prepared in parallel to the planning of this pilot project.

In this design aid, the fundamentals of batch galvanising have been prepared for practical needs that takes the latest research findings into consideration. Useful rules for the application and recommendations for planning and design of hot-dip galvanised components in the construction of steel and composite bridges are provided.

Dipl.-Ing. Heinz Friedrich, German Federal Highway Research Institute (BAST)

January 2016



## 1 | Motivation

Bridges are a part of the infrastructure and contribute to safety in the transport of people and goods. With the gradual expansion of the European Union, the demands made on the European infrastructure, and thus on bridges as well, have also increased. Modifications are necessary, not just in the new member states, but also in Germany with new main traffic arteries with increased through traffic. In this respect, a further 20% increase in the level of road transport is expected in Germany in the coming years [1].

Besides expanding the infrastructure one also has to ensure that existing constructions are maintained. The intensified use of these constructions resulting from the increase in heavy transport and the ageing of existing bridges poses a challenge. Thus the relevance of designing structures to last and including the reduction of life-cycle costs in their economic assessment becomes clear.

Steel and composite bridges are particularly durable and sustainable structures [2]. By using hot-dip galvanised components the design of steel and composite bridges related to corrosion protection can be optimised still further. Hot-dip galvanising offers robust corrosion protection of steel components that will last for many decades without costly servicing and maintenance measures. Hence the direct cost of the maintenance itself as well as indirect costs resulting from traffic disruption are reduced.

Due to a lack of basic technical knowledge and therefore of normative regulations, with the exception of a few cases, hot-dip galvanised components have so far not been used for load bearing structures under cyclic loading. This lack of knowledge was investigated in the past few years as part of a FOSTA research project [3] under the leadership of the Lehrstuhl Stahlbau (Chair of Steel Construction) of TU Dortmund University with its partners MPA Darmstadt and Institut für Korrosionsschutz Dresden GmbH. They conducted systematic investigations for typical conditions into the effect of hot-dip galvanising on the fatigue resistance of steel and composite bridge structures of small and medium spans. In addition, an analysis was made of the possibilities of providing corrosion protection by hot-dip galvanising of the steel construction with the aim of achieving protection for a longer period as well as the use of thermal spraying as a

defined corrosion protection measure for structural welded joints in batch-galvanised components.

This brochure summarises the results of the research work and answers the following questions for the design of steel and composite bridges:

- How does one assess the durability of hot-dip galvanising and where is its optimal field of application?
- What design requirements and limitations need to be taken into consideration?
- What differences are there in the structural design and the verification of fatigue safety for hot-dip galvanised components in comparison to coated components?
- What are the requirements for the erection?
- How should a galvanised bridge be maintained and repaired?

The brochure comments on or supplements the standards in those places that are relevant to the use of hot-dip galvanising components in the design of steel and composite bridges. This provides a design aid for engineers covering the use of hot-dip galvanised components as load-bearing elements in such construction.

## 2 | Conceptual design

### 2.1 | Basics of conceptual design

Generally, a bridge has to be devised, dimensioned and designed so that it retains the required performance characteristics and thus resists the impacts and influences that can occur during erection and use, while taking a service life of 100 years into consideration. Furthermore, it must exhibit an acceptable durability in relation to its maintenance costs. These requirements have to be met by selection of a suitable construction material, dimensioning, structural design and definition of monitoring procedures for fabrication, execution and use.

This design aid for the use of galvanised components in bridge construction deals with these requirements on the basis of the European regulations / Eurocodes. The following additional criteria were taken into consideration for the detailed solutions and examples of steel and composite bridges with small or medium spans that have been prepared:

- **Cost economy:** Investment costs are still the decisive factor today and dominate a construction's architectural impact. Slim and efficient constructions can combine both criteria in many cases. Such superstructures are characterised by less weight that has to be transported and lifted because of the reduced use of materials and this often leads to smaller foundations; foundations usually offer a large potential for cost savings. In addition, the costs for maintenance and repair have to be considered.
- **Aesthetics:** Even though the external appearance of bridge structures is not generally paramount it should nevertheless not be ignored. Otherwise an uncared-for appearance of the infrastructure can impair the perception of the surroundings (this used to be the case especially in rural areas with bridges of small and medium spans). While taking the limited budget into account, the focus should be on those elements that have the greatest impact on the aesthetics of the construction. A simple look at the most common bridges that already exist shows that the surface chosen and the geometry of the construction have a major influence on the architectural perception of the superstructure.
- **Speedy construction:** Usually when construction sites are located in residential areas or at cross-roads of main traffic arteries, the costs for road closures or traffic hold-ups are on a par with the construction costs or even higher. Short construction times with short traffic hold-ups reduce the costs to the user during the construction period and thus limit public expenditure as well, and promote public acceptance of the construction measure.
- **Simple method of construction:** Standardisation of the constructions leads to robust, efficient and simplified methods of construction, simplifies the preliminary planning, cuts construction costs and limits maintenance measures. Furthermore, the simplified method opens up access to the market for a larger circle of companies and thus promotes the development of competitive solutions.
- **Workmanship:** For the most common forms of construction one can ensure good quality despite a limited budget by means of careful planning and use of cost-reducing prefabrication in the workshop while maintaining high standards of fabrication.

- **Long useful life and maintenance costs:** The challenges for the client today are limiting the increasingly higher maintenance costs for existing constructions. For the numerous common bridge structures it is therefore important to develop permanent and cost-saving solutions with limited technical effort. In this way, the maintenance costs can be reduced considerably in future. In this respect, various solutions have already been proposed, such as bridges with integral abutments to limit the necessary pillars and carriageway connections or the use of weather-resistance steels that would make regular coating of the bridge unnecessary. Here, one should draw attention to the necessary corrosion protection of the bridge elements. Considering bridges with galvanised components offers a possible alternative to planning and devising lasting and cost-saving solutions for the future.

## 2.2 | General requirements for corrosion protection of bridge structures

Bridges are constructions that are designed to be used for a very long time. Unless specified otherwise, the service life of a permanent bridge is planned to be 100 years [4]. In order to ensure the durability of the supporting structure, appropriate measures have to be envisaged that either take wear into account or provide protection against any influences by means of adequate precautions.

When constructing steel or composite bridges, protection of the exposed steel structure elements that are thus subject to weathering is usually achieved using corrosion protection systems. Their selection depends on the environmental impacts expected during the service life at the design stage and using these to devise the specific demands on introducing the corrosion protection system, a structural design that is appropriate for corrosion, execution in the factory as well as on the construction site, and the monitoring and if necessary the repair.

Here, the applicable standards and regulations have to be taken into consideration, in Germany especially the



Zusätzliche Technische Vertragsbedingungen und Richtlinien für Ingenieurbauten Teil 4 Stahlbau, Stahlverbundbau - Abschnitt 3 Korrosionsschutz von Stahlbauten (ZTV-ING, technical contract conditions and civil engineering guidelines), the Technische Lieferbedingungen und Technische Prüfvorschriften für Beschichtungsmaterialien für den Korrosionsschutz von Stahlbauten (TL/TPKOR Stahlbauten, technical delivery terms and technical test specifications for coating materials for the corrosion protection of steel structures) [6] and EN ISO 12944 [7].

## 2.3 | Composite bridges with hot-dip galvanized main girders

### 2.3.1 | General

Composite bridge superstructures consist of steel sections as the main girders with a reinforced concrete carriageway slab arranged on top [8]. These structural elements are usually joined together by shear studs. The main girders are stiffened by cross-beams in the area around the bearing. A composite construction is recommended for superstructures with an unlimited or only slightly restricted headway for road bridges with a span up to about 35 m as a single-span girder and up to about 40 m as a continuous girder.

The composite cross-section necessitates designing for two main girders in the case of a slender carriageway slab; more than two main girders, usually with a spacing of 2.40 m to about 3.60 m in the case of a wider carriageway slab or limited headway.

Rolled or welded I-sections are usually used for the main girders. In the event of greater torsional loading of the main girders, box sections are an economical alternative. As a rule, steels with a yield stress of 355 N/mm<sup>2</sup> (S355) are used. However, steels with a yield stress of 460 N/mm<sup>2</sup> (S460) are also becoming increasingly established in composite bridge construction.

Here, the use of the higher strength steel S460 instead of the traditional S355 leads to a significant reduction in the weight of the construction and a corresponding saving in material costs. There is a drop in the processing costs as well: for example, for a full splice the weld volume of the butt weld is significantly smaller.

The rolled sections should be pre-bent the strong axis to adjust to the longitudinal profile of the road and to compensate for the deflection under constant load, and over the weak axis to adjust to the carriageway. For rolled sections, the precambering is usually undertaken in the rolling mill by cold forming on a press. For welded sections, this is also taken into account when assembling the cross-sections. The main girders in single-span bridges usually lie hinged on the abutments. With multi-span bridges the main girders are executed either as multi-single-span girders or as continuous girders. Continuous girders are structurally more favourable (smaller bending moments and smaller deformations) and offer important structural benefits; for example, the number of bearings and the number of carriageway transition structures, whose regular maintenance is expensive, can be reduced significantly.

If the overall length of the bridges and the transport and erection situation allow the main girder can be installed as a finished beam over its whole length. If it is not possible to transport the final length in one piece, the main girder has to be joined in a bending-resistant manner at the construction site. Both welded joints (Section 7.2) and bolted connections with splices (Section 7.3) are proven technique.

Alternatively, it is possible to use onsite joints in longitudinal direction with a continuity effect due to the integration of the single-span girders in a reinforced concrete cross-beam over the supports (Section 6).

The carriageway slab is reinforced longitudinally and transversely. With multi-span bridges, the longitudinal reinforcement should be arranged in the area of the hogging moments in such a way as to ensure limitation of crack widening.

To dissipate the horizontal loads and for stabilisation, the main girders are stiffened over the bearing by cross-beams. These cross beams usually also absorb the forces of the presses with which the superstructure is lifted to replace the bearings.

With two and three span bridges, the loading from the hogging moments can be reduced systematically by selective lowering of the bridge pier once the concrete has hardened.

Simple elastomeric bearings are usually used for composite bridges. With load-transferring components like abutments, pillars and foundations (especially piled foundations), the benefit of the low structural weight of the composite construction leads to smaller component dimensions. The resultant savings in construction costs are characteristic of this method of construction.

### 2.3.2 | Fabrication, transport and erection

Prefabrication of the beams – cutting-to-length in the case of rolled sections, assembly in the case of welded cross-sections, drilling holes, bending over the strong and if necessary the weak axis, welding-on of the support plates and shear connectors, quality assurance and certification, and preparing and applying of the complete corrosion protection – can be carried out in part or completely in the steelworks and/or in a steel construction workshop. With galvanising, intermediate transport to a galvanising plant has to be planned in addition. The ready-to-erect beams are transported to the construction site by rail or truck. The individual components are relatively light and only require simple hoists at the construction site.

Girders are often pre-assembled in pairs in order to give the items to be installed more inherent stability. Building or truck-mounted cranes are used to move the girders or the girder pairs either into their planned, final position above the bridge opening or to a special erection area for later installation. The low mass of the individual components allows the transfer to be carried out quickly; in most cases one can forego the need for erection aids. As far as possible, traffic hold-ups are avoided by execution transport and erection at times of the day when there is little traffic.

## 3 | Durability of hot-dip galvanised components

### 3.1 | Basic principles of hot-dip galvanising

Batch galvanising is a traditional corrosion protection process in which the steel parts are given a metallic coating by immersing them in hot molten zinc. In Germany about two million tonnes of steel are batch galvanised annually, primarily in the fields of metal and steel construction, traffic and infrastructure installations and commercial-vehicle construction. The current plant capacities allow components to be batch galvanised up to a maximum length of 19 m and individual unit weights up to about 10 tonnes.

The galvanising process is basically characterised by a wet-chemical pretreatment, in which the steel surface is cleaned to remove impurities (similar to the bulk material steel, such as rust and scale, and dissimilar, such as oil and grease), followed by the galvanising process in which the construction is immersed in hot molten zinc at about 450°C. The component is surrounded by zinc in the galvanising bath, which reacts with the steel and forms an insoluble, metallurgical bond between the zinc and the steel. The zinc-iron alloy phases formed in this way usually exhibit a higher hardness than the steel and are thus particularly hard-wearing. These zinc-iron-phases are covered with a pure zinc phase that deposits when the component is withdrawn from the melt (Fig. 1).

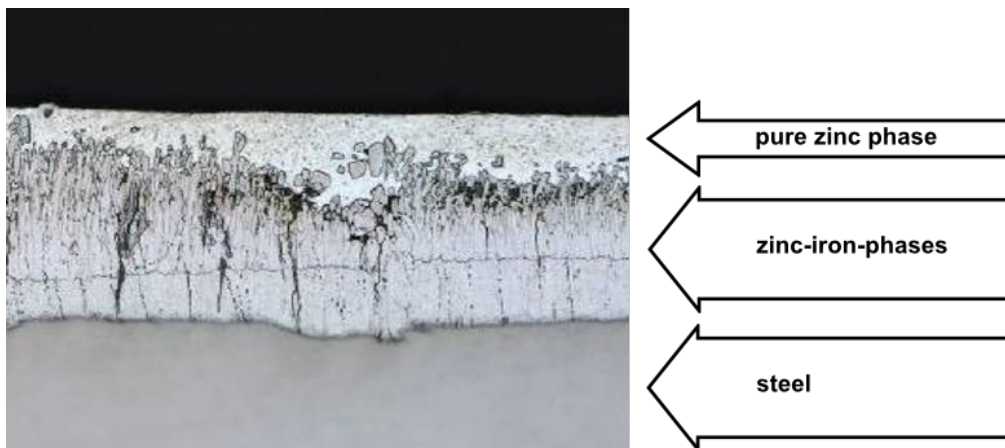

Fig. 1: Microscopic representation of the structure of a zinc layer formed in a classical batch-galvanising process

### 3.2 | Characteristics of the zinc layer

The zinc layer formed in the batch galvanising process protects the steel construction in two ways. Firstly, the zinc coating acts as a barrier and keeps the corrosive medium, e.g. saline air, from coming into direct contact with the steel and attacking it (passive corrosion protection). Further zinc prevents corrosion processes on iron, the more noble metal, via the cathodic protection effect (active corrosion protection). Here, the zinc acts as a sacrificial anode, which means that even if the protective zinc layer is locally damaged, the steel will not be attacked because the less noble element, zinc, is sacrificed instead and thus protects the steel.

The formation of the zinc layer occurs by a thermal diffusion process, i.e. an exchange of zinc and iron atoms during the time the steel construction is immersed in the molten zinc, with the associated formation of the zinc-iron alloy phase. The rate at which the thickness of the zinc layer increase up during galvanising depends on the characteristic of the steel, the structural design and the galvanising process parameter.

#### 1. Influence of the bulk material

The reaction between zinc and iron is mainly controlled by the reactivity of the steel, which in turn depends on its chemical composition, especially its silicon and phosphorus contents, and the galvanising temperature. This dependence is presented graphically in Fig. 2.

#### 2. Structural design

The type of construction as well as the plate thicknesses and the dimensions of the material influence the necessary galvanising time. A longer exposure time in the molten zinc is necessary with massive constructions than with thin material which leads to a longer reaction between zinc and iron and than to thicker zinc coatings.

#### 3. Galvanising temperature

In principle the process temperature has an effect on the reaction rate. In practice, however, there are barely any differences within the industry; the usual galvanising temperature is 445-455°C, so that this parameter is of little relevance.

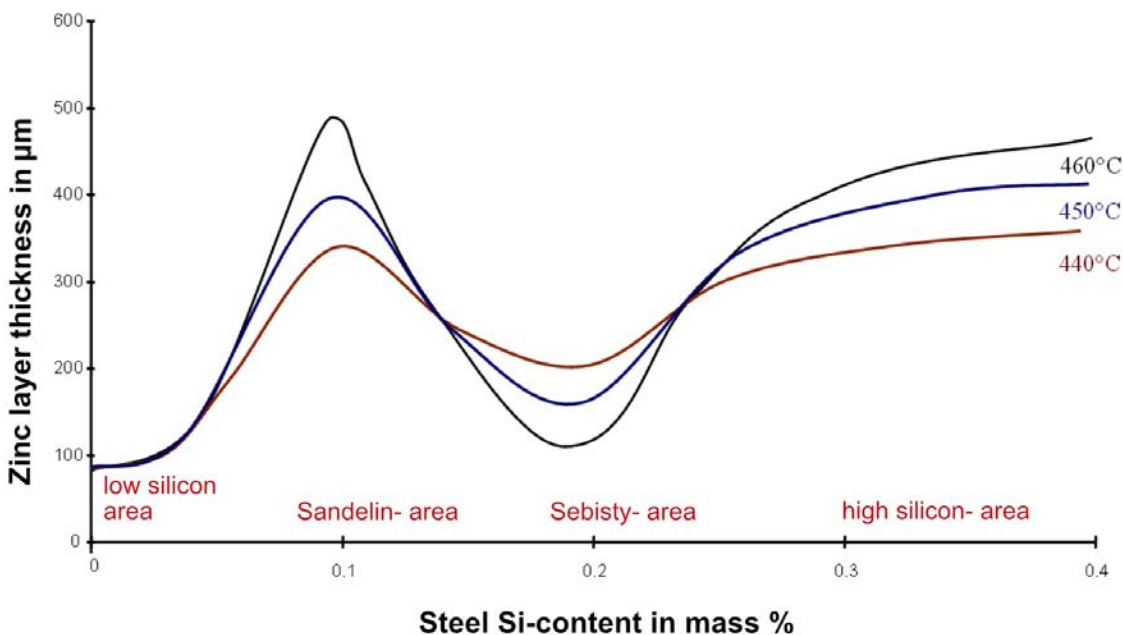

Fig. 2: Effect of steel Si content on the thickness of zinc coatings (immersion time: 10 min, phosphorus < 0,02 mass%) [3]

Minimum zinc coating thicknesses as a function of the thickness of the basis material are given in EN ISO 1461 [9]. With material thicknesses > 6 mm, which are typical for steel construction, the minimum value of the average layer thickness is 85 µm. In practice, thicknesses between 100-300 µm are common. Depending on the desired service life in the project-specific corrosive media, zinc coating thicknesses can be higher than the standardised values if necessary. In this case it is recommended to ensure beforehand that the required layer thickness is achievable by using samples.

### 3.3 | Design of the corrosion protection

In view of the durability of a steel construction, i.e. its long-term stability, the corrosion protection system chosen and the corrosive environment at the place of use have to be considered in their entirety. For the project planning, the site-specific exposure to corrosion, also taking into account possible microclimatic impacts, should be evaluated by an expert. Depending on the aggressiveness of the attacking media, the zinc layer is removed to a certain extent, thus it is consumed with time. EN ISO 12944-2 [10] provides information on the extent of the zinc corrosion rate in the case of atmospheric exposure. Based on the amount of chlorides and sulphides in the air, the standard classifies the environmental conditions into so-called corrosivity categories with details of the corresponding rates of zinc erosion in µm per year (Table 1).

During the planning of a bridge structure the minimum zinc layer thickness determined in this way and the zinc corrosion rates based on the standard according to [10] offer a very good basis for assessing the maintenance-free service life of the construction and thus a high degree of planning reliability. Taking a zinc layer thickness

of 200 µm and assuming the zinc corrosion rate is linear over time, for example in a C3 climate, the expected service life of the corrosion protection is at least 95-285 years (corrosion rate 2.1 µm/a or 0.7 µm/a), and for C4 exposure with up to 4.2 µm/a it is 47 years.

With the values given in Table 1 one should note, however, that the zinc corrosion rate was measured on test samples after one year and thus after a time period during which the zinc loss values are at their highest. The ingress of carbon dioxide (CO<sub>2</sub>) onto the zinc surface has a significant influence on the corrosion rate. In the presence of CO<sub>2</sub>, not only are carbonate layers formed but also corrosion products with good protective properties for the underlying zinc layers. Under normal atmospheric conditions, the corrosion products themselves can thus slow down the corrosion rate significantly by forming covering layers and sealing defects such as pores [11]. This leads to the dependence of the zinc corrosion rate becoming asymptotic with time (cf. Fig. 3). The estimation of the maintenance-free service life of a zinc coating based on the assumption of a linear rate of removal is therefore conservative.

Another important factor for the corrosion rate is the sulphur dioxide (SO<sub>2</sub>) content of the atmosphere. The strongly corrosive effect of sulphur dioxide on zinc coatings exposed to the atmosphere can be attributed, above all, to two effects [12]:

1. the ingress of sulphur dioxide leads to a reduction of the pH,
2. zinc sulphates are readily soluble corrosion products.

Even with a slight increase in the SO<sub>2</sub> concentration, this leads to stronger attack of the zinc coating. Generally,

Table 1: Classification of the corrosivity categories according to EN ISO 12944-2 [10]

Corrosivity category	Corrosivity	Expected rate of zinc loss [µm/a]
C1	very low	$r_{\text{corr}} \leq 0.1$
C2	low	$0.1 < r_{\text{corr}} \leq 0.7$
C3	moderate	$0.7 < r_{\text{corr}} \leq 2.1$
C4	high	$2.1 < r_{\text{corr}} \leq 4.2$
C5 (industrial / marine)	very high	$4.2 < r_{\text{corr}} \leq 8.4$

however, one should remember that air pollution has declined steadily in Germany and Europe in recent decades, especially SO<sub>2</sub> pollution. In large areas of Germany, the rates of zinc corrosion are now around 1 µm/a, partly even significantly lower, and thus within the range of the corrosivity categories C2 and C3.

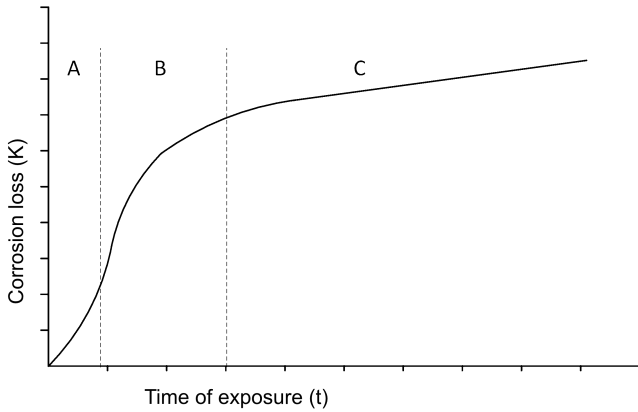

Fig. 3: Schematic representation of zinc removal with time [13]

The following formula (3.1) from EN ISO 9224 [14] can be used to determine the relationship shown in Fig. 3 and thus to estimate the protection period based on a realistic removal of zinc:

$$D_{tZn} = r_{corr,tZn} \cdot t^b \quad (3.1)$$

where:

t: the exposure period, expressed in years

b: the specific time exponent for zinc and the surroundings, usually less than one

r<sub>corr,tZn</sub> the corrosion rate of zinc available for the first year, expressed in grams per square metre and year [g/(m<sup>2</sup> / a)] or in micrometres per year [µm/a], in accordance with ISO 9223 [15].

Taking a zinc layer thickness of 200 µm as an example, a nominal rate of zinc removal in a C4 atmosphere of up to 4.2 µm/a results in an expected protection period of at least 83 years (3.2). This is significantly longer than the 47 years determined conservatively on the basis of a linear rate of removal.

$$\sqrt[b]{\frac{D_{tZn}}{r_{corr,tZn}}} = t = 0.873 \sqrt[0.873]{\frac{200 \mu\text{m}}{\text{max. } 4.2 \mu\text{m}}} \geq 83.5 \text{ years} \quad (3.2)$$

This leads to the following recommendation: to achieve an expected service life of the same order of magnitude as the life of a bridge under moderately corrosive conditions, namely 100 years, one should set the minimum zinc layer thickness to 200 µm. It is possible that under more aggressive atmospheric conditions it might be necessary to repair the corrosion protection after about 80 years (Fig. 4).

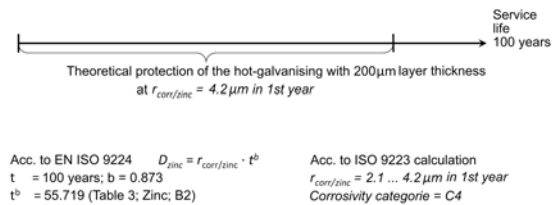

Fig. 4: Theoretical protection period for hot-dip galvanising (200 µm) [13]

However, if the trend towards further improvements with regard to atmospheric pollution continues, it is even possible to expect longer protection period. In practice, zinc coating thicknesses of more than 200 µm on hot-dip galvanised steel components are common.

### 3.4 | Repair of zinc layers

#### 3.4.1 | General

Hot-dip galvanizing is carried out completely in a factory using the process described above. Nevertheless, it might be necessary to repair the zinc layer later as a result of process or construction related defects, transport or erection related damage, the need for welding work on components that have already been galvanised, or if the zinc layer has been completely removed over time, for example as a result of locally enhanced corrosion.



According to EN ISO 1461 [9], the process to be used here is thermal spraying with zinc (spray metallising / zinc spraying) according to EN ISO 2063 [16], whereby the provisions presented below should be fulfilled. The use of other methods of repair is not recommended for bridge construction. Zinc-dust coating primer in accordance with ZTVING [5] or TL/TPKOR Stahlbauten [6] Annex E Sheet 87 or Sheet 89 are not suitable because of the particularly long protection period required; experience has shown that these repair coatings only have a protection period of 10 to 20 years. Furthermore, zinc solders and zinc sprays are also unsuitable for repairing defects in batch galvanised components.

Defects arising from the galvanising process have to be rectified in the hot-dip galvanising plant whereas the repair of transport damage or the renewal of the corrosion protection on joints welded during erection can be carried out at the construction site. One has to ensure that the necessary construction site facilities needed to carry out the process properly (housing, controlled relative humidity, etc.) are available and budgeted for.

#### 3.4.2 | Surface preparation

The surface areas to be repaired by thermal spraying have to be prepared to level P3 on the steel side in accordance with EN ISO 8501-3 [17] or EN 1090-2 [18]. In order to create a good connection with the batch galvanised layer, the intact zinc layer adjacent to the non-galvanised area should also be prepared by slight blasting (so-called sweeping).

A surface roughness grade at least  $R_{y5} = 85 \mu\text{m}$  (G) with Sa3 surface preparation should be obtained on the steel and a roughness of max.  $R_{y5} = 40 \mu\text{m}$  (G) on the hot-dip galvanising. Suitable processes should be used and if necessary a suitable sample should be prepared. Refer also to Section 7.2 concerning the actual execution of the work.

The hot-dip galvanised layer should be masked to avoid damage to the existing intact zinc layer outside the localised surface preparation. This is only necessary, however, to sharply delineate between the spray metallising plus the sealing and the hot-dip galvanising. The mask remains in place until completion of the spray metallising on the hot-dip galvanised surface and must exhibit appropriate durability.

#### 3.4.3 | Thermal spraying

Thermal spraying should be applied in accordance with the requirements of EN ISO 2063 [16]. The blasted and swept surface areas have to be coated using spray metallising within four hours after surface pretreatment. The spray metallising should overlap the intact zinc coating by at least 30 mm. Refer also to Section 7.2 concerning the actual execution of the work.

#### 3.4.4 | Pore-sealing treatment

According to ZTV-ING Part 4, Section 3 [5], a pore-sealing coating should be applied to the spray-metallised surface areas promptly after thermal spraying. After sealing, the repair of the hot-dip galvanising corrosion protection system is complete and the protection (masking) of the intact hot-dip galvanised area should be removed. Refer also to Section 7.2 concerning the actual execution of the work.

### 3.5 | Duplex Systemes

In the field of heavy-duty corrosion protection, the term 'duplex system' refers to the combination of hot-dip galvanising with an additionally applied organic coating. This can be applied as a single or multi-layer wet or powder coating.

The idea behind duplex systems is to create specially formulated corrosion protection solutions by complementing the corrosion protection characteristics of the one system with those of the other. These systems are used particularly in applications where the following applies:

- a. Increased durability.
- Fields of application in which enhanced corrosion rates of zinc are to be expected as a result of specific, often localised conditions, such as areas of increased chemical loading, a particularly large impact from de-icing salt or permanent humidity, play a particularly important role here. The combination can increase the duration of the corrosion protection by a factor of 1.2-2.5 compared with the sum of the protection periods of the two individual systems.



#### b. Aesthetic design.

The numerous coatings available mean it is possible to colour a construction without having to forego the properties of the zinc layer as a high-quality form of corrosion protection.

For bridge construction, duplex systems using a wet-paint coating are used exclusively. Depending on the specific application, a multi-layer structure with a thickness of 120–240 µm can be applied, whereby usually the primer and if necessary the intermediate coat are applied in the factory and the top coat on site.

During application one must take care to ensure that the coating system used is compatible with a hot-dip galvanised substrate. Recommendations on the choice of system are offered by EN ISO 12944-5 [7], Table A.7 for corrosivity categories up to C5 and the *Zusätzliche Technische Vertragsbedingungen und Richtlinien für Ingenieurbauten ZTV-ING* [5], Teil 4 Stahlbau, Stahlverbundbau. Adequate and proper preparation of the galvanised surface must be carried out, e.g. by sweep blasting, before applying the primer coat. The coating material producer's specific processing instructions must be observed.

### 3.6 | Contact with concrete

Hydrogen and calcium hydroxyzincate are formed when zinc reacts with moist concrete. This corrosion product is insoluble and protects the underlying zinc (provided the surrounding concrete mix has a pH of under approx. 13.3) [19].

Investigations have shown that during this initial reaction period a part of the pure zinc layer of the coating is dissolved until passivation of the coating and a hardening of the concrete occur. This initial reaction ends, however, with the hardening of the concrete and the formation of a hydroxyzincate layer. Investigations on galvanised reinforcing steel removed from structures that had already been processed showed that the passive condition of the coating was maintained for a longer period even when high chloride contents in the vicinity of the concrete pose a burden [19].

For types of concrete with a high pH, the zinc coating can be passivated using patented post-treatments to protect it against excessive hydrogen formation when a higher chloride ingress is expected [19].

## 4 | Basics of galvanising-specific design and construction

### 4.1 | General

The dimensioning and design relevant background information and principles that have to be taken into consideration in the dimensioning and structural design of hot-dip galvanised steel or composite bridge structures are explained in the following. The design instructions should be regarded as supplementary to the general design principles of steel and composite bridge construction.

### 4.2 | Normative regulations

The normative basis of the recommendations made in this brochure are the European regulations for steel and composite bridge construction. Standards that influence the galvanising of the bridge elements and batch galvanising are as follows:

EN 1993-1-9 [20]

EN 1993-2 [21]

EN 1994-2 [22]

EN ISO 1461 [9]

EN 10025 [23]

EN ISO 12944 [24]

EN ISO 14713 [19]

In addition, in Germany the DAST Guideline 022 [25] applies for load-bearing components, and thus also for the execution of a bridge structure.

For traffic constructions that come under the sovereignty of the federal and state authorities in Germany, consideration must be given additionally to the *Zusätzliche Technische Vertragsbedingung für Ingenieurbauwerke (ZTV-ING* [5]). These can also be agreed for other constructions.

Given that the current regulations in DAST Guideline 022 (status 2009) [25] and ZTV-ING [5] (status August 2015) do not foresee hot-dip galvanising where there is cyclic and dynamic loading of load-bearing components, a Zustimmung im Einzelfall (ZiE, approval in the individual case) has to be obtained from the responsible authorities before designing a hot-dip galvanised bridge. Other country-specific requirements and regulations outside of Germany have to be examined and taken into consideration in good time by the planner.

### 4.3 | Design-relevant features of galvanising

The formation of the zinc layer occurs as a result of a metallurgical bond between zinc and steel (formation of a zinc-iron alloy layer). The characteristics of the layer affect

1. the fatigue behaviour of the bulk material and the structural details, as well as
2. the bolting behaviour of batch-galvanised components.

With regards to fatigue behaviour, micro solidification cracks have a negative effect; these always form to a certain extent in the zinc layer when the construction cools after galvanising because of the differing thermal expansion coefficients of zinc and steel. However, the results from [3] allow the conclusion to be drawn that with increasing intensity of the structural notch the significance of these micro-notches becomes secondary. Generally, in order to take this into consideration in the dimensioning it is necessary to use up to one notch detail category lower (Section 5.3).

With regard to bolting behaviour, the zinc layer causes a reduction in the coefficient of friction. Corresponding measures are necessary to counteract this effect (Section 5.2).

### 4.4 | Construction-relevant features of galvanising

#### 4.4.1 | Fundamental aspects

When designing steel constructions that are to be galvanised, there are two aspects that are particularly important for the design engineer and have to be heeded accordingly:

#### a. Batch galvanising is an immersion process.

With regards to possible dimensions and weights, the construction is subject to the limitations of the galvanising plant (dipping baths und hoists). This means that with bridge structures segmentation of the whole construction is necessary and even with short spans one has to plan for site splices (for the design of the corrosion protection in the area of the joint see Section 3.4). In Germany there are galvanising plants available throughout the country with bath dimensions of approx. 16 x 1.8 x 2.8 m (LxWxH) and 10 tonnes lifting capacity, with larger baths at some locations.

Anchorage points have to be provided for transport within the galvanising plant and during the actual galvanising process.

The liquid process media (pretreatment liquids, molten zinc) into which the construction is immersed have to wet the whole surface of the component completely, but these have to be able to run off in the same way, either when it is removed from the respective process bath. Provision should also be made for inlet, flow-through and outlet openings for the liquids as well as for vents to avoid entrapped pockets of air.

#### b. Batch galvanising is a process at higher temperature.

Due to the impact of heat at approx. 450°C, the construction expands in the molten zinc by about 4.5 mm/m. This expansion evolves with increasing through heating of the material, which in turn is dependent on the plate thickness and the immersion rate; it can occur non-uniformly depending on these parameters over the whole geometry of the component. One has to estimate how the construction will behave under such loading (deformation behaviour) and where constraints can possibly occur as a result of non-uniform expansion.

Compared with room temperature, the elastic modulus  $E$  of the bulk material will decline with increasing temperature, until it is about 50-60% at 450°C. The resultant reduction in the axial and flexural stiffness combined with the material and fabrication-related internal stresses can lead to these being relieved.

The construction contracts again when it is removed from the molten zinc and begins to cool down, and recovers its strength completely at the same time.

#### 4.4.2 | Basic principles of hot-dip galvanising friendly design

Hot-dip galvanised steel constructions have proven themselves in steel building construction, i.e. under mainly static loading, due to their longevity. Besides having a design that is suitable for corrosion protection in accordance with EN ISO 12944-3 [24] and EN ISO 14713-1 [19], additional requirements regarding hot-dip galvanising friendly construction according to EN ISO 14713-2, Annex A [19] and DAST Guideline 022 [25] must be taken into consideration in the hot-dip galvanising process in order to achieve optimal corrosion protection.

##### Holes for draining and venting

The construction should have sufficiently large cut-outs and draining openings, possibly at ribs in the form of circular cuts. The draining holes in the end spans should be carried out in the web as circular cuts with at least 50 mm diameter as well.

To reduce loading, there should be a sufficient number of adequately sized draining and venting holes in the construction, especially with hollow sections. This ensures that the structure will be immersed into the molten zinc as fast as possible, which in turn will minimise the inhomogeneity of the temperature development over the height of the component and thus the induced stresses. It is a case here, of course, of balancing the structurally possible with what is necessary from a galvanising point of view.

When producing the holes, the specifications with respect to the cut-edge quality given in EN 1090-2 [18] must be followed.

##### Plate thicknesses, plate thickness ratios, changes in stiffness

At structural notches, especially in the area of changes in thickness and stiffness, thermal loading during the galvanising process can lead to local concentrations of stress or to relative deformation, which can result in localised overloading of the bulk material [26].

To avoid this, reference is made to the rules and recommendations of DAST Guideline 022 [25]. Notwithstanding this, it is recommended to maintain a plate thickness ratio of  $t_{\max}/t_{\min} \leq 2.5$ .

##### Maximum component size

The maximum possible component dimensions have to be discussed and agreed with the galvanising plant.

Double dipping in case of oversize should be avoided.

##### Surface finish, cut edges

The surface finish of the rolled sections and plates used must conform to EN 10163-2 [27], Class B, Sub-group 3. Before hot-dip galvanising, the level of preparation of the construction should be P3 (very thorough preparation) in accordance with EN ISO 8501-3 [17]. Here, for example, untreated thermally cut edges are not permitted and all edges must be rounded with a minimum radius of 2 mm. One can forego the rounding of rolled edges on sections and plate. Here, the P2 level of preparation (thorough preparation) is adequate.

##### Bending and forming

It is not allowed to use cold-worked and cold-formed components with a deformation ratio higher than the maximum value given in [25].

#### 4.4.3 | Avoidance of distortion due to internal stresses

The heating up of steel parts in the zinc bath, which has a temperature of approx. 450°C (cf. 4.4.1), is responsible for distortion that might possibly occur during hot-dip galvanising due to stress relief. At this temperature, the yield stress of the steel is lower than the value at room temperature: about 60-80% depending on the steel grade.

At very high internal stresses in a steel construction, it is possible that the existing stress peaks will be relieved by plastic deformation. If the internal stresses in a construction are considerably higher than the yield stress of the steel, which is reduced temporarily during hot-dip galvanising, the steel cannot withstand these internal stresses any longer. The stresses are relieved by plastic deformation – and distortion occurs.

Internal stresses are present to a greater or lesser degree in every steel construction and are usually completely unproblematic in hot-dip galvanising. They can be present, for example, in the form of rolling, deformation or welding stresses and are normally in mutual equilibrium and initially have no reason to undergo deformation. However, the introduction of heat by hot-dip galvanising can unbalance this situation and deformation might result.

In order to have a design that is suitable for hot-dip galvanising and the subsequent hot-dip galvanising process, a welding sequence plan for low-stress fabrication has to be prepared. The key measures for reducing the risk of distortion are symmetrical cross-sections, a symmetrical arrangement of the welded joints, dimensioning the welded joints so that they are not larger than necessary, and choosing a welding procedure with low energy input per unit length. In view of the subsequent erection, the welding sequence specified should be conducted in an identical manner for all components.

#### **4.4.4 | Avoidance of distortion due to differing cooling behaviour**

Besides the release of fabrication-related internal stresses, the differing cooling behaviour of individual components of batch-galvanised welded constructions are a further potential cause of possible distortion. The effect that occurs here is that the more rapidly cooling slender components, or generally components that have a large surface-volume ratio, regain their original, temperature-dependent stiffness earlier and thus are subjected to compressive stress by the bulkier, less rapidly cooling component; a localised stability problem can thus arise depending on the specific temperature and stiffness states.

To avoid such effects, it is particularly important to limit differences in plate thickness, to design for restraint-free thermal shape changes and provide suitable storage during the cooling process [28].

## **4.5 | Material selection**

When choosing the steel grade one should first take into account the order specification in accordance with EN 10025 [23] 'Hot-dip galvanising'.

Given the correlation between the chemical composition of the steel and the resultant zinc layer thickness presented in Section 3.2, and in view of the need to achieve a minimum zinc layer thickness, it is recommended to specify the Si and P contents (see also Table 1 in EN 14713-2 [19]).

For a targeted zinc layer thickness of at least 200 µm, a steel with a silicon content in the range  $0.14 \leq \text{Si} \leq 0.35\%$  and a phosphorus content of  $\text{P} \leq 0.035$  should be used. It is advisable to produce samples in advance to examine the practical feasibility of the required zinc layer thickness. The Si and P contents of all plate and sections used should be similar within the above-mentioned limits to avoid an uneven appearance.

With regards to the necessary fracture toughness, one should observe the requirements according to Table 3 of the DAST Guideline 022 [25] in addition to the requirements of the bridge standard [21] [29] (Table 2).

Components with markedly scaled surfaces or a strong onset of rust should be blasted before galvanising (Sa 2½) in order to have short pickling times in the galvanising plant.

Table 2: Choice of steel grade as a function of the reference value of the component height and the strength class

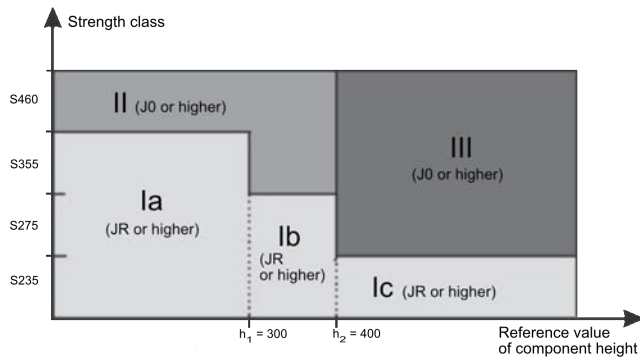

(..) = Minimum toughness requirement

**Key:**

- Class Ia: Sections (open sections and hollow sections)
- Class Ib: Sections of IPE and HE series or similar \*
- Class Ic: Sections of IPE and HE series or similar \*
- Class II: Sections of IPE and HEA series or similar \*
- Class III: Sections of IPE and HEA series or similar \*

\* for welded sections with similar dimensions as the rolled sections

Note: The reference values of the component height were determined for thin-walled, deep-webbed sections with  $h/h_1 \approx 40$ . A conceivable increase of the limiting values  $h_1$  and  $h_2$  for  $h_{tw} \leq 40$ , as a result of the slow through-heating, was not considered

Note: With the DAST Guideline 022 [25], HEB, HEM and HL sections are covered on the safe side by HEA.

## 4.6 | Transport

The anchorage points or lifting lugs envisaged should be used when loading for transport (Fig. 5).

In order to avoid the risk of spalling at very high coating thicknesses as a result of localised mechanical loading, the components should be adequately protected against damage during transport. It might be necessary here to have appropriate additional edge protection for the transport (e.g. at points where the load is secured).



Fig. 5: Lifting lug



## 5 | General information on concept, design and construction

### 5.1 | Verification of load-carrying capacity and serviceability limit state

The relevant standards and rules on dimensioning, such as EN 1993-2 [21] and EN 1994-2 [22], also apply to hot-dip galvanised bridge supporting structures – with two exceptions: there are only changes to the verifications of the load-carrying capacity and the serviceability limit state for bolted, slip resistant connections as a result of changed coefficients of friction. Furthermore, consideration has to be given to differing detail categories with respect to the assessment of material fatigue in EN 1993-1-9 [20].

### 5.2 | Design of bolted connections for hot-dip galvanised components

A spliced connection is recommended for a bolted connection as an alternative to a butt welded joint. The splice connection can be carried out on hot-dip galvanised steel components without damaging or partially removing the corrosion protection at the connection. This eliminates the need to post-treat the

connection using spray metallising or an organic coating, which means the corrosion protection of up to 100 years will be unimpaired.

Fit bolt connections or slip resistant connections are permitted for use in bridge construction [4]. The disadvantage of a conventional fit bolt connection is the large effort required to produce the pass fit. A slip resistant connection is therefore usually the most economical solution. Slip resistant connections are divided into the categories B and C according to EN 1993-1-8 [30] (Table 3). They are preferably used in constructions that require a force-locked and low-deformation component connection as well as for constructions subjected to fatigue loading.

They include high-strength preloaded bolts. Depending on the category, as a rule the design value of the sliding resistance may not be exceeded in the serviceability limit state or in the load-carrying capacity limit state. The design value of the shear force in the load-carrying capacity limit state may not exceed the design value of the shear load capacity and the bearing stress resistance.

According to EN 1993-1-8 [30], the following verifications have to be provided for a recommended slip resistant connection of the category C:

Table 3: Bolted connection categories [30]

Category	Criteria	Remarks
<b>Shear connections</b>		
A bearing type	$F_{v,Ed} \leq F_{v,Rd}$ $F_{v,Ed} \leq F_{b,Rd}$	No preloading required. Bolt classes from 4.6 to 10.9 may be used.
B slip-resistant at serviceability	$F_{v,Ed,ser} \leq F_{s,Rd,ser}$ $F_{v,Ed} \leq F_{v,Rd}$ $F_{v,Ed} \leq F_{b,Rd}$	Preloaded 8.8 or 10.9 bolts should be used. For slip resistance at serviceability see 3.9.
C slip-resistant at ultimate	$F_{v,Ed} \leq F_{s,Rd}$ $F_{v,Ed} \leq F_{b,Rd}$ $F_{v,Ed} \leq N_{net,Rd}$	Preloaded 8.8 or 10.9 bolts should be used. For slip resistance at ultimate see 3.9. $N_{net,Rd}$ see 3.4.1(1) c).
<b>Tension connections</b>		
D non-preloaded	$F_{t,Ed} \leq F_{t,Rd}$ $F_{t,Ed} \leq B_{p,Rd}$	No preloading required. Bolt classes from 4.6 to 10.9 may be used. $B_{p,Rd}$ see Table 3.4.
E preloaded	$F_{t,Ed} \leq F_{t,Rd}$ $F_{t,Ed} \leq B_{p,Rd}$	Preloaded 8.8 or 10.9 bolts should be used. $B_{p,Rd}$ see Table 3.4.
The design tensile force $F_{t,Ed}$ should include any force due to prying action, see 3.11. Bolts subjected to both shear force and tensile force should also satisfy the criteria given in Table 3.4.		



### 1. Sliding resistance

$$F_{s,Rd} = \frac{k_s \cdot n \cdot \mu}{\gamma_{m3}} \cdot F_{p,C} \quad (5.1)$$

where:  $k_s$ : factor, see Table 3.7, EN 1993-1-8 [30]  
 $n$ : number of friction surfaces  
 $\mu$ : slip factor determined per EN 1090-2 [18] or Table 3.7, EN 1993-1-8 [30]  
 $F_{p,C}$ : pretensioning force of the bolt according to EN 1090-2 [18]  
 $\gamma_{m3}$ : safety factor

### 2. Shear resistance of bolt

$$F_{v,Rd} = \frac{\alpha_v \cdot f_{ub} \cdot A}{\gamma_{m2}} \quad (5.2)$$

where:  $\alpha_v$ : factor, see Table 3.4 EN 1993-1-8 [30]  
 $f_{ub}$ : tensile strength of bolt material  
 $A$ : cross-sectnl. area of bolt in shear plane  
 $\gamma_{m2}$ : safety factor

### 3. Bearing resistance of bolt

$$F_{b,Rd} = \frac{k_1 \cdot \alpha_b \cdot f_u \cdot d \cdot t}{\gamma_{m2}} \quad (5.3)$$

mit:  $k_1$ : factor, see Table 3.4 EN 1993-1-8 [30]  
 $\alpha_b$ : factor, see Table 3.4 EC 1993-1-8 [30]  
 $f_u$ : tensile strength of assembly components  
 $d$ : diameter of bolt  
 $t$ : plate thickness min [t component, t splice]

### 4. Net cross-section is determined according to EN 1993-1-1 as follows [31]

$$\frac{N_{ed}}{N_{net,Rd}} \leq 1.0 \quad (5.4)$$

where:  $N_{ed}$ : acting tensile force  
 $N_{net,Rd}$ : load-carrying capacity net cross-sectional area according to Eq. 6.8, EN 1993-1-1 [31]

For verification of the sliding resistance, the tension forces of the bolts are regulated in the product standard EN 1090-2 [18] or can be calculated according to EN 1993-1-8 [30] as follows:

$$F_{p,C} = 0.7 \cdot f_{ub} \cdot A_s \quad (5.5)$$

where:  $f_{ub}$ : tensile strength of the bolt  
 $A_s$ : stressed cross-section of bolt

The frictional resistance of the material has a considerable influence on the slip resistance. This is taken into consideration in the calculation in the form of the coefficient of friction  $\mu$  in Equation (5.1). The coefficient of friction depends on the actual slip factor, which in turn depends on the type of surface preparation. Generally, there are four slip factors, A to D, which are shown in Table 18 of EN 1090-2 [18]. The corresponding surface preparations to be used are also described in detail there. Regardless of the slip factor, the areas of contact must still be completely free of impurities (e.g. oil or paint residues) and burrs that would prevent the parts to be joined from seating firmly.

Stressed friction-grip connections with hot-dip galvanised surfaces in the shear plane lead to sliding creep deformation under constant load. Depending on how pronounced the different phases in the zinc layer are (from a pure zinc layer to a rougher mixed surface layer), the achievable slip factor can vary between  $\mu = 0.10$  and  $\mu > 0.50$  [32] [33].

In a draft version of prEN 1090-2 (version: July 2015) that has not been adopted, an additional category has been introduced for hot-dip galvanised and swept surfaces. A slip factor of  $\mu = 0.35$  was proposed.

Treatment of the slip surfaces can be undertaken to set the slip factor to a defined value and thus be able to safely estimate the load-carrying capacity of the bolted connection. The most effective measure consists of applying a zinc silicate coating (ASi in TL 918300 Sheet 85) to a previously swept hot-dip galvanised surface. Although this usually leads to a slip factor of  $\mu = 0.5$  being achieved, slightly lower values were also obtained in scientific tests conducted with constant static and dynamic loading [32]. Therefore for bridge constructions a slip factor of  $\mu = 0.4$  (class B) should be chosen.

As a result of the effects of creep due to the additionally applied alkali silicate coating, there is sometimes a loss in the tension forces in the bolts which depends on the strength and thickness of the coating. A reduced pre-tensioning force means, however, that the possibility of load transmission by friction is reduced. It is therefore recommended to control the prestressing of the bolts a few days after assembly and if necessary readjusted. A major part of the pre-tensioning force losses can be seen within the first few minutes after the initial tightening. The initial pre-tensioning force can be restored by retightening the bolts.







### **5.3 | Verifications of fatigue resistance**

In addition to structural design, the rules given in EN 1993-2 [21], EN 1993-1-9 [20] and EN 1994-2 [22] should be used for the necessary assessment of material fatigue.

Assessment of fatigue is performed by comparing loads with loading capacities. To determine the loading capacities, the fatigue strength curves (S-N curves) in EN 1993-1-9 [20] for standard detail categories based on nominal stresses are used. These are the result of the evaluation of results from fatigue tests [3] [34] on large scale test specimens (notch details) with geometric and structural imperfections, that result from the steel production and component fabrication (e.g. fabrication tolerances and internal stresses resulting from welding) [5]. Galvanised components are not explicitly covered by the standard.

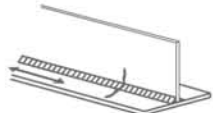
Based on new tests on batch-galvanised notch details the detail-category table in the standard could be complemented [3] [35]. Table 4 should be used to determine the loading capacities of hot-dip galvanised components. If there are components in the supporting structure that are subjected to fatigue loading, that cannot be derived from this for their verification, it is necessary to carry out special examinations, choose a more precise verification process or establish monitoring scenarios.

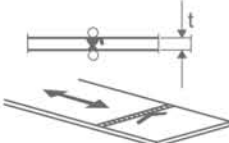
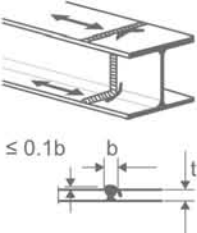
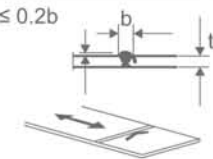
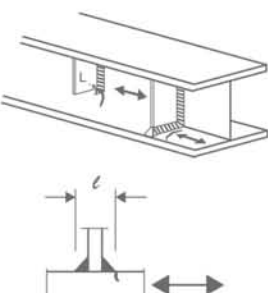
Table 4: Detail categories for hot-dip galvanised details [3] [35]

Detail Category	Construction Detail	Description	Requirements
140	 <p>Note: Detail category 140 is thus the highest possible for hot-dip galvanised components</p>	Plates, flats and rolled sections with rolled/milled edges	Sharp edges, surface and rolling flaws to be improved by grinding until removed and smooth transition achieved.
112		Machine gas or waterjet cut having shallow and regular drag lines. Machine gas or waterjet cut with cut quality according to EN 1090.	Re-entrant corners to be improved by grinding (slope $\leq 1/4$ ) or evaluated using the appropriate stress concentration factor. No repair by weld refill.
100		Manual longitudinal fillet welds	A very good fit between the flange and web plate is essential.
80		Continuous longitudinal fillet weld carried out across a complete penetration transverse weld	
100		Size effect for $t > 25$ mm $k_s = (25/t)^{0.2}$ Transverse splices in plates and flats	<ul style="list-style-type: none"> <li>○ All seams to be ground flush parallel to load direction.</li> <li>○ Weld run-on and run-off pieces to be used and subsequently removed, plate edges to be ground flush in direction of stress.</li> <li>○ Welded from both sides, checked by NDT.</li> </ul>
80	 <p><math>\leq 0.1b</math></p>	Size effect for $t > 25$ mm $k_s = (25/t)^{0.2}$ Full cross-section butt welds of rolled sections without cope holes.	<ul style="list-style-type: none"> <li>○ The height of the weld convexity to be <math>\leq 10\%</math> of weld width, with smooth transition to plate surface.</li> <li>○ Weld run-on and run-off pieces to be used and subsequently removed, plate edges to be ground flush in direction of stress.</li> <li>○ Welded from both sides, checked by NDT.</li> </ul>
80	 <p><math>\leq 0.2b</math></p>	Size effect for $t > 25$ mm $k_s = (25/t)^{0.2}$ Transverse splices in plates, flats, rolled sections or welded plate girders.	<ul style="list-style-type: none"> <li>○ The height of the weld convexity to be <math>\leq 20\%</math> of weld width, with smooth transition to plate surface.</li> <li>○ Weld not ground flush</li> <li>○ Weld run-on and run-off pieces to be used and subsequently removed, plate edges to be ground flush in direction of stress.</li> <li>○ Welded from both sides, checked by NDT.</li> </ul>
80		$t \leq 50$ mm Vertical stiffeners welded to a beam or plate girder.	<ul style="list-style-type: none"> <li>○ Ends of welds to be carefully ground to remove undercuts.</li> <li>○ <math>\Delta\sigma</math> to be calculated using principal stresses if the stiffener terminates in the web, (see sketch on left).</li> </ul>
80 ( $m = 8$ )		Weld stud shear connectors: shear stud in composite action	$\Delta\tau$ to be calculated from the nominal cross section of the stud.

It should be noted that downgrading the fatigue resistance of hot-dip galvanised slightly notched components by up to one detail category compared with non-galvanised components can be regarded as non-critical for the cost economy of the dimensioning. For example, for a farm road bridge with a low traffic load and a medium span the verification of the fatigue resistance plays a subordinate role in the dimensioning. As a rule, therefore, this down-grading does not lead to any larger cross-section dimensions either (cf. Chapter 9).

## 6 | Configuration of details for galvanised steel and composite bridges

### 6.1 | General

In principle, the configuration of simple and plain details leads to sustainable and durable structures. Besides configuring the layout of the details the configuration should also avoid surfaces with standing water and accumulations of dirt, provide for weather-resistant surfaces and enable possible repair and maintenance, e.g. of the corrosion protection, to be carried out.

For construction details, that often occur in road bridge construction, reference drawings have been prepared for the individual detail configurations on the basis of experience and published as 'Richtzeichnungen für Brücken und andere Ingenieurbauwerke' (Reference Drawings for Bridges and Other Civil Engineering Structures) together with ZTV-ING [5] with which it is to be used. It is recommended to use them in order to guarantee the service life of bridges.

One has to match the materials to be used with the methods used to protect them against the climatic influences (rain, snow, frost, etc.) and chemicals (chlorides and sulphates) to which they are exposed. This means choosing adequate concrete covering and the right concrete composition for the carriageway slab to avoid or limit the ingress of chlorides and carbonation.

In addition, a good sealing system for the carriageway slab coupled with functioning drainage plays a decisive role in the durability of the elements to be found under the carriageway slab. Water contaminated by de-icing salt should be avoided under the seal of the carriageway slab. One should note here that the service life of the road

surface itself should be 25 years for a road bridge constructed in cement concrete and 15 years for one constructed in bituminous concrete or mastic asphalt.

Ease of maintenance is the basis for guaranteeing the ultimate limit state, serviceability limit state and above all the durability throughout the service life of a bridge structure. This means execution maintenance and repair continuously, and making this possible by means of accessibility and inspectability of the construction details. The effect of a measure on the operation can already be estimated during the design phase.

Caps and wearing parts, such as bearings and expansion joints, must be replaceable independently of the load-bearing structure. As a rule, they have a service life of 30 to 40 years.

### 6.2 | General information on loading-relevant configuration of details for galvanising

Besides the provisions for materials and sections specified in Section 4.4.2, DAST Guideline 022 [25] contains a classification of construction details into different detail classes (A, B, C), which reflect the increasing influence of the structural notch effect on the stresses that occur during galvanising processes. The favourable variants, classes A or B, should be used to configure the detail. Furthermore, provisions should be made for longer immersion times for product thicknesses > 30 mm.

Reference is made to Section 4.4.2 for general information on the configuration of details.

### 6.3 | Standard details of composite bridges with small or medium spans

Composite bridges with small or medium spans are characterised by simple configuration of the details and are thus well suited to hot-dip galvanising. The main girders across the bearings are stiffened using cross-beams to transmit the horizontal loads and for stabilisation. With continuous girders, one has to prevent lateral torsional buckling of the compressively loaded bottom flanges in the areas of negative moments at supports by designing appropriate bearing cross-beams

and, if required, additional cross-beams in span.

The following variants are common as cross-beams across the bearings:

- steel cross-beams that are connected to the main girders by bolting or welding (Section 6.3.1).
- reinforced concrete cross-beams, whereby the reinforcing bars are passed through holes in the web of the main girders. These can be carried out with direct or indirect support of the main girders (Section 6.3.2 and Section 6.3.3).

As a rule, steel cross-beams are envisaged for horizontal stiffening in the span. One differentiates between cross-beams connected by bolted or welded joints to the main girders (Section 6.3.4).

### 6.3.1 | Steel cross-beams over end supports and intermediate supports

#### 6.3.1.1 | Welded connection of an I-beam at a support

Generally, I-sections (for rolled sections typically IPE or HE) are used as welded-on steel cross-beams. A typical detail configuration is to weld the steel cross-beam to the main girder by means of a butt weld using a T-rib in the section chamber (Fig. 6). The T-rib can be cut from an HE section and adapted to the dimensions of the main and cross beams. The T-rib is also often made from plates welded in the chamber.

Alternatively, the cross-beam can also be welded directly onto the main girder (Fig. 7).

For a galvanising-friendly design, openings for draining are necessary in the areas of the connections of the cross-beam to the main girder (Figs. 6 and 7, on right in each case). When using a T-rib, provision should be made in the rib web for two openings in each of the lower and upper corners of each chamber.

With both variants, provision should also be made for an opening in each of the four corners of the cross-beam web.

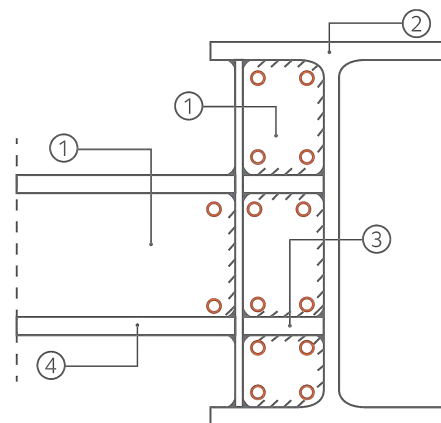

Diameter of the drilling hole:  $d \geq 1,5 \times t_{web}$   
 $d \geq 15\text{mm}$

1 =  $t_{web}$ , 2 = main girder, 3 = stiffener, 4 = cross-beam

Fig. 6: Execution of detail of an I cross-beam welded onto a T-rib; left: a practical example during fabrication; right: execution with the required drainage openings



The openings can be circular or quadrant-shaped cut-outs. As a guide for the required diameter of the opening one can use  $d \geq 1.5 \times t_{\text{web}}$ , but at least 15 mm, for the circular cuts and the required radius  $R \geq t_{\text{web}} + 3 \times a$  (where  $a$  = thickness of weld seam), but at least 25 mm, for quadrant-shaped openings.

The details have to be discussed and agreed with the galvaniser on a case-by-case basis, especially also the use of drilled holes as anchorage points for the galvanising process.

The construction details should be considered in accordance with DAST Guideline 022 [25], Table 4: as follows

- welded-in T-rib: Detail 6 of detail class A (the openings in the rib web do not lead to any significant loading and can be ignored)
- cross-beam with end plate and flow-through openings in the web: Detail 1a of detail class B.

With both variants of a welded cross-beam connection, one should ensure that the width of the main girders that are grouped together by the cross-beams does not exceed the width of the galvanising baths. Although possible in principle, it is not recommended to galvanise the assembly by turning it through 90° so that the main girders are in a horizontal position because this will have a negative effect on the galvanising quality.



If it is not possible to galvanise main girders that are grouped together, it is not advisable to subsequently weld in the cross-beams in the chambers of the galvanised main girders. A bolted variant is recommended in this case (Section 6.3.1.2). However, if the cross-beams should be nevertheless welded in, the stubs for the supports should be welded onto the main girder before galvanising. After galvanising, the cross-beams are then welded onto these using butt connections. Welding and the subsequent application of the corrosion protection must be carried out in accordance with Sections 3.4 or 7.2.

### 6.3.1.2 | Bolted connection of an I-beam at a support

A bolted connection of an I-shaped cross-beam in the area of the support can be carried out as an alternative to a welded connection. In an analogous manner to Section 6.3.1.1, the cross-beam is connected to the welded-in T-rib on the main girder using an end plate (Fig. 8).

Another possibility is to connect the cross-beam to the end of a cross-beam welded to the main girder using bolted splices (Fig. 9).

The connection of the end of the cross-beam to the main girder is carried out using a butt weld to the web of the main girder. For load transmission and stiffening, the whole area of the chamber between the flanges has to be stiffened with plates.

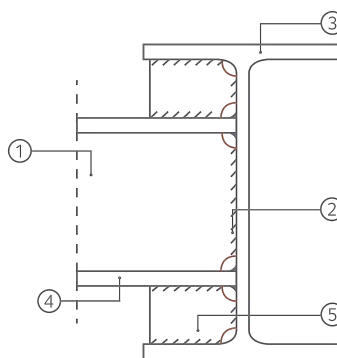

Radius of cut-out:  $R \geq t_{\text{web}} + 3 \times a$  or  $t_{\text{brace}} + 3 \times a$   
 $\geq 25\text{mm}$

1 =  $t_{\text{web}}$ , 2 =  $a$  (thickness of weld seam), 3 = main girder,  
 4 = cross-beam, 5 =  $t_{\text{brace}}$

Fig. 7: Pre-assembled pair of main girders with welded-on cross-beam; left: practical example of transport; right: execution with drainage openings for galvanising



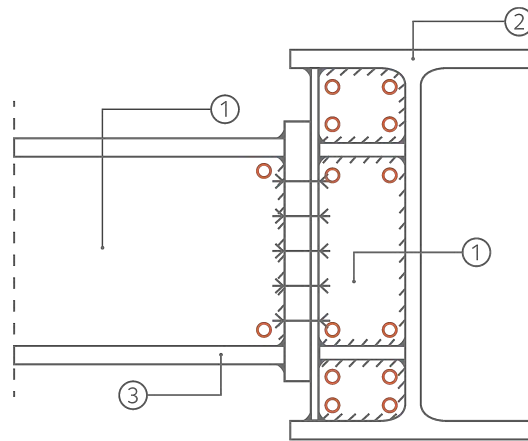

Diameter of the drilled hole:  $d \geq 1,5 \times t_{web}$   
 $\geq 15 \text{ mm}$

1 =  $t_{web}$ , 2 = main girder, 3 = cross-beam

Fig. 8: Execution of detail of a T-rib for bolted connection of an I cross-beam; left: practical example of erection; right: execution with drainage openings for galvanising

For a galvanising-friendly design, openings for draining are necessary in the areas of the connections of the cross-beam to the main girder. When using a T-rib, provision should be made in the rib web for two openings in each of the lower and upper corners of each chamber. On the sides of the cross-beam provision should be made for an opening in each corner (top and bottom) behind the end plate.

With a spliced connection, an opening has to be envisaged in each of the two corners of the stub for the support that is welded onto the main girder. No additional openings are necessary on the sides of the cross-beam.

The openings can be circular or quadrant-shaped cut-outs. As a guide for the required diameter of the opening one can use  $d \geq 1,5 \times t_{web}$ , but at least 15 mm, for the circular holes and the required radius  $R \geq t_{web} + 3 \times a$  (where  $a$  = thickness of weld seam), but at least 25 mm, for quadrant-shaped openings.

The details have to be discussed and agreed with the galvaniser on a case-by-case basis, especially the use of drilled holes as anchorage points for the galvanising process.

The construction details should be considered in accordance with DAST Guideline 022 [25], Table 4 as follows:

- welded-in T-rib: Detail 6 of detail class A (the openings in the rib web and flange do not lead to any significant loading and can be ignored)
- cross-beam with end plate and flow-through openings in the web: Detail 1a of detail class B
- cross-beam with drilled holes in the web with  $d \geq 25 \text{ mm}$ : Detail 3 of detail class A
- cross-beam with drilled holes in the web with  $d < 25 \text{ mm}$ : Detail 2 of detail class B

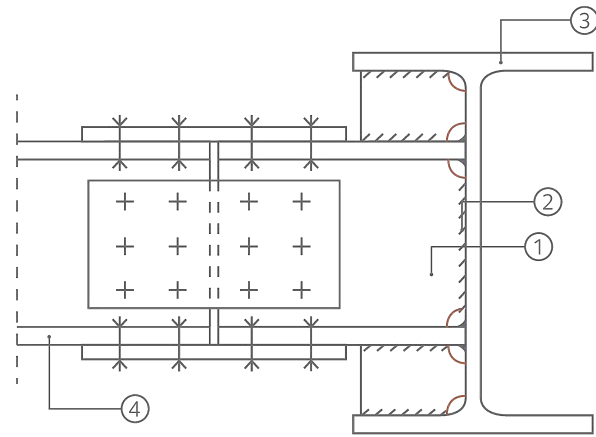

Diameter of the drilled hole:  $R \geq t_{web} + 3 \times a$   
 $\geq 25 \text{ mm}$

1 =  $t_{web}$ , 2 = main girder, 3 = cross-beam

Fig. 9: Execution of detail of spliced connection of an I cross-beam; left: a practical example of an installed beam; right: execution with drainage openings for galvanising

### 6.3.2 | Concrete cross-beam on end support

Concrete cross-beams are bridge elements that ensure the configuration of a restraint of the beams at the abutments using an in-situ concrete surrounding. In addition, the concrete cross-beams have the advantage that they connect the main beams monolithically in the transverse direction and thus increase the resistance to torsion and warping. With carriageway slabs with small spacings between the main girders, cross-beams are therefore usually only necessary in the assembled state to stabilise the main girders and can be removed once the concrete has hardened.

Typical configurations of concrete cross-beam at abutments are shown in Fig.10.

For an ideal design of the main girder, there should be provision for flow-through openings in the upper and lower corner behind the end plate. As a guide for the required diameter of the opening one can use  $d \geq 1.5 \times t_{web}$ , but at least 15 mm, for the circular holes.

The construction details should be considered in accordance with DAST Guideline 022 [25], Table 4 as follows:

- main girder with end plate and drainage openings in the web: Detail 1a of detail class B.

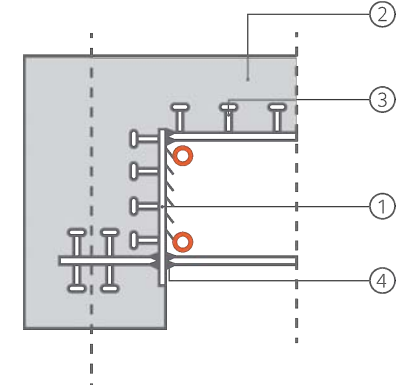
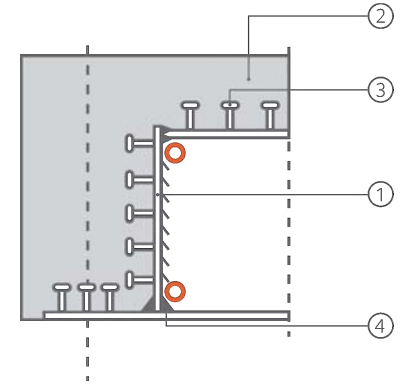
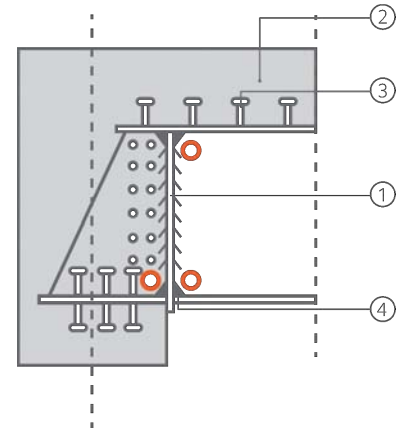

Diameter of the drilled hole:  $d \geq 1,5 \times t_{web}$   
 $\geq 15 \text{ mm}$

1= main girder, 2 = concrete slab,  
 3 = shear stud, 4 = weld seam

Fig. 10: Execution of detail of concrete cross-beam at abutments; left and centre: practical examples of fabrication, erection and installed beam; right: execution with drainage openings for galvanising

### 6.3.3 | Concrete cross-beam over intermediate supports

With multi-span bridges, cross-beams made of reinforced concrete can also be arranged over the intermediate supports. The advantage of the concrete cross-beams compared with steel cross-beams is that together with an appropriate configuration of the detail they can serve simultaneously as an overlap connection of the main girder and thus compensate for the overlap connections made necessary by the limited length due to the zinc bath or the shipment. In this way, classical solutions, like a bolted or welded main girder connection, can be replaced by a concrete cross-beam. Splicing work that has to be carried out at the construction site and often generates problems, especially at small construction sites, can thus be reduced markedly by planning reinforced concrete cross-beams over the columns. This form of execution corresponds to that used for prestressed bridges with immediate bond, whereby the beams are made of steel and prefabricated concrete parts.

The cross-beam consists of a reinforced concrete beam with rectangular cross-section of a width of 90 to 150 cm and a height the same as or greater than that of the main girders (Fig. 14). The moment-resisting connections are prepared using end plates (Figs. 12 and 13) and precise reinforcement of the cross-beams and the carriageway

slab (Fig. 11). In the longitudinal direction of the bridge the whole system acts as a single-span beam during the concreting (dead loads from the main girder, shuttering, fresh concrete). The hardening of the concrete results in a moment-resisting connection so that the system produces hogging moments solely via the traffic and additional loads. This combines the following advantages:

- The Main girders are erected as single-span beams and connected using in-situ concrete:
  - o The spans can be built successively. This helps to minimise traffic disruption due to the construction site and thus also the negative economic impacts.
  - o By planning the construction sequences, one can influence either the deflection of the main girder in the construction phase or the stresses of the concrete cross-beam connections: if the concrete cross-beam is produced first, the steel beam is already integrated in the span during the concreting of the carriageway slab and the deflection resulting from the weight of the fresh concrete is reduced by 80%. If the concreting of the cross-beams takes place at the same time as the carriageway slab, the deflection, that has to be compensated by pre-cambering of the main girder in the workshop



Fig. 11: Practical example: preparation for the concrete cross-beam over intermediate support – Oberhartmannsreuth Viaduct





Fig. 12: Detail with welded-on end plate



Fig. 13: Detail with a load distribution plate welded onto the bottom flange

is higher, but the stress analysis of the concrete cross-beam connections and the crack width verification over the support only have to be carried out for the additional loads and the traffic loads. As a rule, one can dispense with the need for expanding the steel beam at the support.

- The full splices (bolted or welded), needed when the length is limited by fabrication or transport, can be attached to the concrete cross-beam:
  - o Splicing work at the construction site can be reduced. In addition, with short main-girder spans it is possible for the corrosion protection to have a homogenous structure without disturbing the galvanised layer at the splice.
  - o Compared with a steel construction, a connection using in-situ concrete is more favourable with regards to the tolerances, that have to be adhered to at the construction site.
  - o At the construction site it is not necessary to have specialist knowledge in steel construction. Pre-fabrication can be carried out under factory

conditions in a cost-effective manner and to a high quality standard. The impact of subsections on the construction site and the construction site organisation is minimised by just-in-time delivery of the ready-to-install girders.

How a concrete cross-beam works structurally can be summarised quite simply. The negative bending moment on the support is split into a couple consisting of a compressive force and a tensile force. The compressive force is transmitted by contact (either by direct contact of bottom flange against bottom flange using pressure plates or by indirect contact via the concrete in the case of an end-plate connection). The end plates are welded onto the girders or the bottom flange with full-penetration welds.

The tensile force is transferred completely by the reinforcement. The shear studs on the upper flanges transfer the bending tensile forces into the carriageway slab and its longitudinal reinforcement and thus transfer the tensile forces across the cross-beams. To achieve this, reinforcement has to be added above the bearings and anchored in the span. The shear force is transferred to the concrete cross-beam either via the welded studs on the support webs (connection with pressure plates) or on the end plate (end-plate connection).

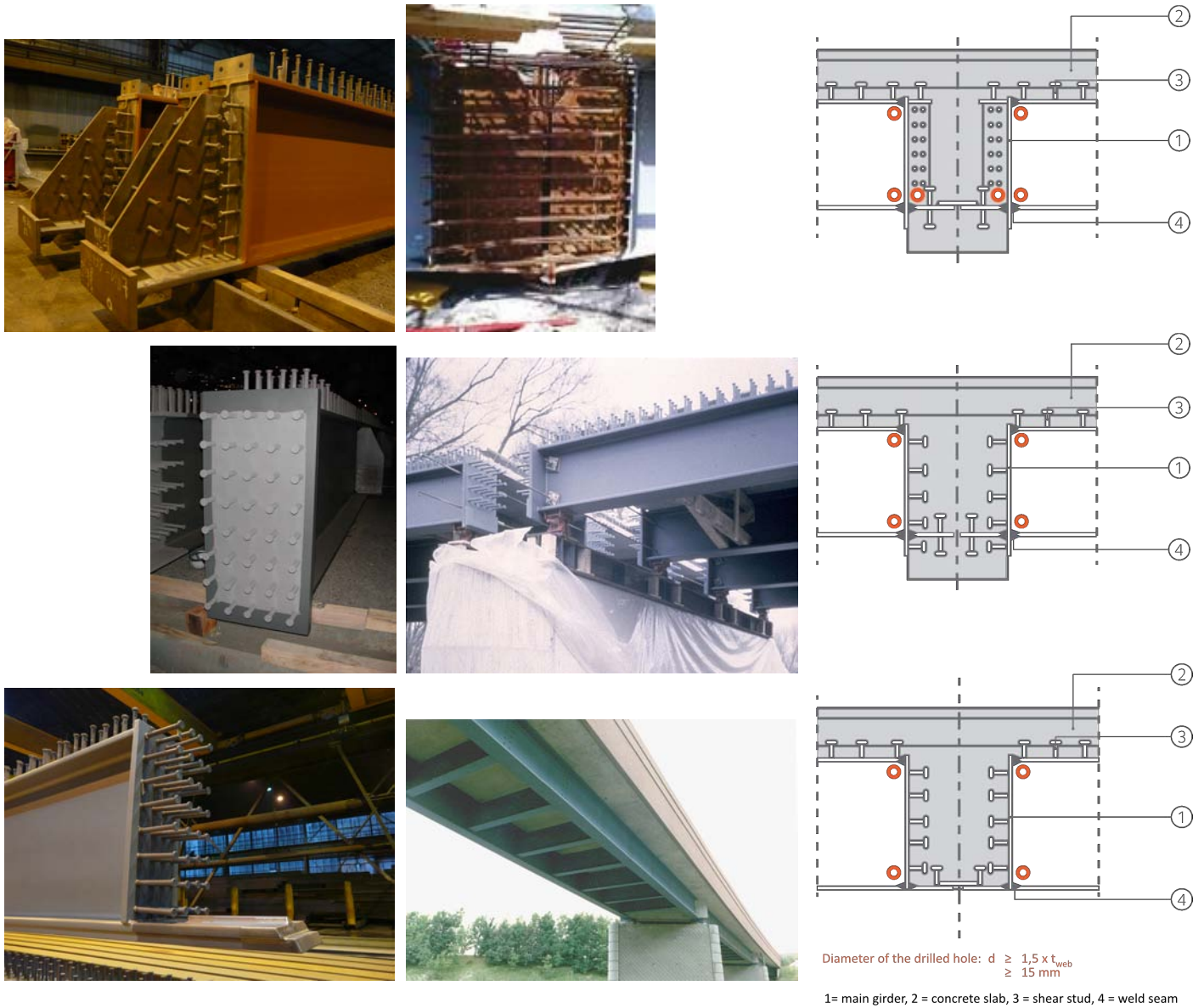

Fig. 14: Execution of detail of concrete cross-beam as intermediate support; left and centre: practical examples of fabrication, erection, installed condition; right: execution with drainage openings for galvanising

Similar details are also used to execute the end supports of bridges with integral abutments. The conceptual design is thus carried out in an analogous manner. The same advice and recommendations as in Section 6.3.2 apply for the galvanising-friendly execution.

### 6.3.4 | Steel cross-beams within span

#### 6.3.4.1 | General

The most economic option of the lateral distribution of the loads is carried out exclusively via the concrete carriageway slab. Accordingly, cross-beams serve only to

stabilise the longitudinal girder during the construction phases (securing the girder against lateral torsional buckling in areas of positive moments). After the concrete has hardened, the carriageway slab takes on this function so that the cross-beams can be removed. With continuous girders, one has to avoid lateral torsional buckling of the compressively loaded bottom flanges in the areas of negative hogging moments by designing appropriate bearing cross-beams and, if required, additional cross-beams within the span.

Possible detailed designs of cross-beams within the span are shown in the following sections. There are bolted and welded details.



### 6.3.4.2 | Bolted connection of I-beam with T-rib within span

One variant of a bolted detail configuration for connecting steel cross-beams with the span is analogous to the T-rib connection as end cross-beams (Fig. 8, see Section 6.3.1.2). I-cross-beam sections are usually chosen from the IPE or HE section series. With appropriate execution, the connection can be classified as resistant to bending.

The same advice and recommendations as in Section 6.3.1.2 apply for galvanising-friendly execution.



Fig. 15: Execution of detail of a bolted connection of an I-beam to a T-rib welded onto the main girder; practical example during construction

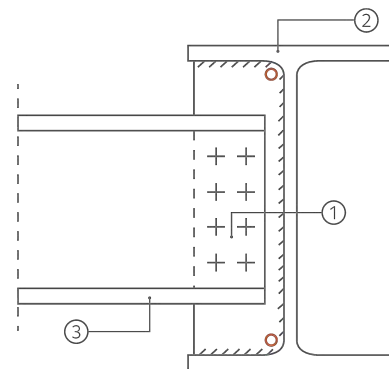

Fig. 16: Execution of detail of U-cross-beam bolted to a stiffening plate; left: practical example during construction; right: execution with drainage openings for galvanising

### 6.3.4.3 | Bolted connection of I- or U-cross-beam with stiffening plate within span

As long as one can guarantee that during construction the distribution of lateral forces only occurs via the cross-beams and there is no bending-resistant connection in a planar manner, an I- (IPE or HE) or U-cross-beam web (UPN) can be bolted to a stiffening plate welded into the chamber of the main girder (Fig. 16). The dimensions of the stiffening plate are adapted to those of the main girder. In this way one can reduce the prefabrication costs and improve the notch details at the bottom flange compared with a welded-in T-brace. In addition, the erection is simpler than one in which cross-beams are bolted to a T-rib using end plates.

The same advice and recommendations as in Section 6.3.1.2 apply for the galvanising-friendly execution.



Diameter of the drilled hole:  $d \geq 1,5 \times t_{web}$   
 $\geq 15 \text{ mm}$

1 =  $t_{web}$ , 2 = main girder, 3 = cross-beam

#### 6.3.4.4 | Welded connection of I- or U-cross-beam to stiffening plate within span

The detail of an I- or U-cross-beam connected using a stiffening plate (Section 6.3.4.3) can also be carried out using a welded connection (Fig. 17). When selecting the web strengthening, a welded connection can be used for partial fixing of the cross-beams. A welded execution only makes sense, however, if pairs of girders can be galvanised together over the whole length or the partial length. Here one needs to take into account the width of the galvanising baths. Although possible in principle, it is not recommended to galvanise the assembly by turning it through 90° so that the main girders are in a horizontal position, because this will have a negative influence on the quality of the galvanising. Likewise, it is not advisable to subsequently weld in cross-beams after galvanising with subsequent application of corrosion protection.

For a galvanising-friendly design, openings for draining to the web of the main girder are necessary in the corners of the connecting plates, which can be circular or quadrant-shaped cut-outs. As a guide for the required diameter of the opening one can use  $d \geq 1,5 \times t_{\text{web}}$ , but at least 15 mm, for circular cuts and the required radius  $R \geq t_{\text{web}} + 3 \times a$  (where  $a$  = thickness of weld seam), but at least 25 mm, for quadrant-shaped openings. In order to prevent the

accumulation of moisture in the overlap between the cross-beam and the connection plate, which can lead to vapourisation during the galvanising process and a build-up of pressure, relief drill holes with  $d \geq 12$  mm should be envisaged every 300 mm in the web of the cross-beam.

The details have to be discussed and agreed with the galvaniser on a case-by-case basis, especially also the use of drilled holes as anchorage points for the galvanising process.

The construction details should be considered in accordance with DAST Guideline 022 [25], Table 4 as follows:

- welded-in rib: Detail 5 of detail class A (the openings in the rib web do not lead to any significant loading and can be ignored)
- welded face of the connection plate to the cross-beam flange: Detail 3 of detail class B

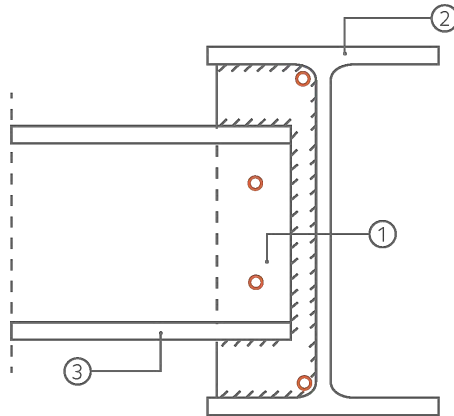

Diameter of the drilled hole:  $d \geq 1,5 \times t_{\text{web}}$   
 $\geq 15 \text{ mm}$

1 =  $t_{\text{web}}$ , 2 = main girder, 3 = cross-beam

Fig. 17: Execution of detail of welded U-cross-beam connection to stiffening plates including web reinforcement of the main girder; left: practical example of fabrication; right: execution with drainage openings for galvanising

### 6.3.4.5 | Direct bolted connection of I-beam to web of main girder

As an alternative, the I-cross-beam can be bolted directly to the web of the main girder using an end plate (Fig. 18). This connection detail, which is typical for bridges made of rolled beams in concrete, can be copied in composite bridges for non-continuous cross-beams or edge beams. An advantage is the small amount of prefabrication effort and the fact that the connection does not adversely affect the fatigue category of the bottom flange. This detail can be used reasonably with preassembled pairs of girders. If the cross-beams are first installed after the hoisting of the main girder, they have to be swung into position but damage to the corrosion protection must be avoided.

For a galvanising-friendly design, openings for draining are necessary in the corners of the cross-beam web to the end plate. As a guide for the required diameter of the opening one can use  $d \geq 1.5 \times t_{web}$ , but at least 15 mm.

The details have to be discussed and agreed with the galvaniser on a case-by-case basis, especially the use of drilled holes as anchorage points for the galvanising process.

The construction details should be considered as follows in accordance with DAST Guideline 022 [25], Table 4:

- drilled holes in web of main girder with  $d \geq 25$  mm: Detail 3 of detail class A
- drilled holes in web of main girder with  $d < 25$  mm: Detail 2 of detail class B
- cross-beams with end plate and drainage openings in web: Detail 1a of detail class B.

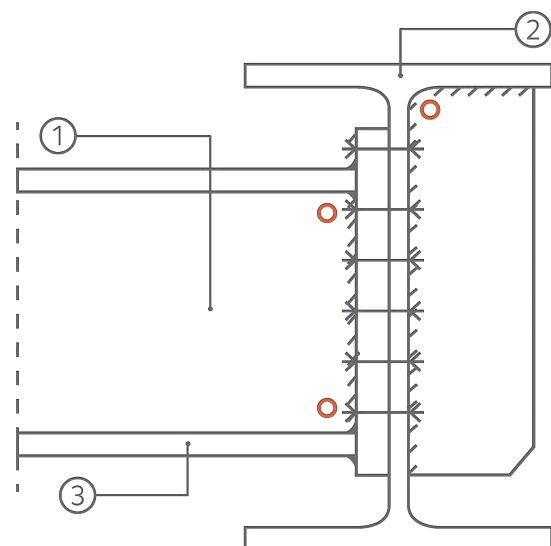

Diameter of the drilled hole:  $d \geq 1,5 \times t_{web}$   
 $\geq 15$  mm

1 =  $t_{web}$ , 2 = main girder, 3 = secondary girder

Fig. 18: Execution of detail of bolted end plate connection for the I-cross-beam on the main girder; left: practical example as erected; right: execution with drainage openings for galvanising



Fig. 19: Execution of detail of I-cross-beam welded to the web of the main girder

#### 6.3.4.6 | Welded connection of I-cross-beam directly to web of main girder

As an alternative, the I-cross-beam can also be welded directly onto the web of the main girder in a similar manner to Section 6.3.1.1. The chamber of the main girder has to be augmented with stiffening plates above and below the cross-beam flange in order to ensure a structural load application. This detail can also be used reasonably with preassembled pairs of girders. These can be galvanised together over the whole length or the partial length.

Here one needs to take into account the width of the galvanising baths. Connecting support stubs, galvanising and subsequently complementing the galvanised cross-beams using a bolted connection (Fig. 9) is also possible for cross-beams within the span. It is not recommended to weld in cross beams after galvanising with the need of subsequent touch-up the corrosion protection.

The same advice and recommendations as in Section 6.3.4.4 apply for the galvanising-friendly execution.

## 7 | Execution of galvanising-specific site-splice details

### 7.1 | General preliminary considerations

Site splices should be envisaged if bridge main girders of more than about 16 m length cannot be hot-dip galvanised because of the limitation on the maximum component size and the maximum component weight. In this case the beams are fabricated in segments and subsequently hot-dip galvanised.



Fig. 20: Hoisting of preassembled pair of girders and subsequent welding of I-cross-beams to the prefabricated support stub

The position of the site splices should be arranged so that they are as favourable as possible with respect to loading and also for access for control and maintenance purposes. Splices should be carried out preferably outside the traffic lanes or at least very close to the edge of the traffic lanes, for example to reduce traffic disruptions to a motorway going under a bridge when it possibly becomes necessary to repair to corrosion protection at the splices.

### 7.2 | Detail of welded butt joint

#### 7.2.1 | Installation process and configuration of detail

Assembling galvanised elements into a component with the required component length can also be accomplished by means of a welded butt joint if necessary. The position and execution must be coordinated with the construction planning and the dimensioning. The joints should be shown on the detailed drawings.

In order to avoid zinc deposition during hot-dip galvanising in the areas where site splices are to be welded (including the end faces), these have to be covered over a sufficiently wide area (recommendation: approx. 100 mm [3] [13]) with a suitable masking lacquer in accordance with the preparation instructions of the coating manufacturer.

After hot-dip galvanising, the individual beam segments have to be welded together. These welded joints should be carried out in the factory as far as possible to ensure optimal conditions for the execution. Only in the event that the whole beam cannot be transported to the





Fig. 21: Weld seam preparation for a welded butt joint of hot-rolled wide-flange beams for a composite bridge

construction site welded joints should be carried out at the construction site.

To execute the butt weld, run-on and run-off plates in accordance with EN 1090-2 [18] in the Execution Classes EXC3 and EXC4 must be used. These have to be removed after welding. As a rule, one can forego the use of run-on and run-off plates for a butt weld of the web of I-beams. DV weld seams (Fig. 22, left) require four beam positions for fabrication: twice horizontal and twice vertical. By comparison, the welding joint variant with V seams (Fig. 22, right) only requires two beam positions, twice lying, and is thus easier to fabricate. The weldseam volume and

thus also the welding time is twice as much. Both variants are possible in principle and the advantages and disadvantages have to be balanced.

Preheating possibly needed in the area of the welded splice can be carried out using heating pads in order to ensure that the specific uniform heat input into the plate is achieved. It is imperative to avoid unexpected overheating of the hot-dip galvanised surfaces adjoining the splice by a hot flame.

The convexity in the seam should be ground flush mechanically at the end of the welding operations.

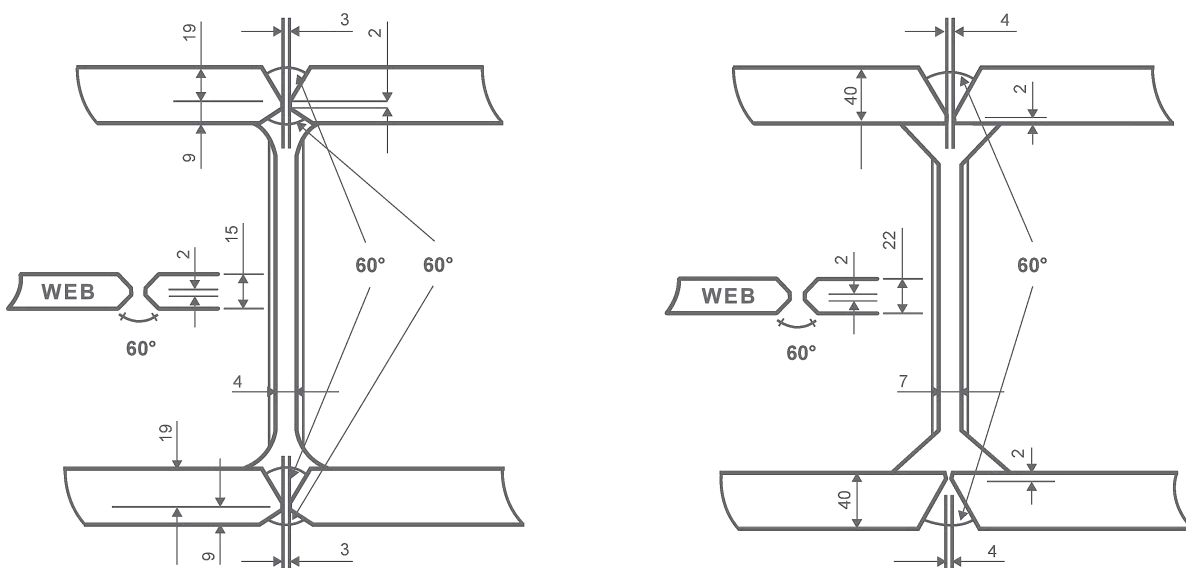
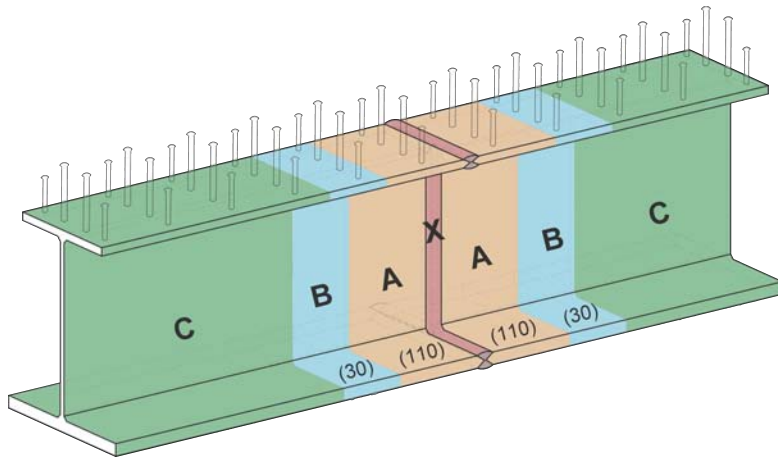

Fig. 22: Details of possible ways of executing the weld seams for butt joints



- X: weld seam area
- A: area of welded site splice to be repaired using spray metallising
- B: transition area spray metallising – batch galvanising
- C: unaffected batch galvanised layer

Fig. 23: Execution of welded site joint [36]

### 7.2.2 | Application of corrosion protection to welded joint

Based on and in addition to Point 5.5 ZTV-ING welded site splices, the corrosion protection process described in Section 3.4 was developed for welded site splices of hot-dip galvanized components [3] [13]. The surface preparation and subsequent spray metallising in the area of the welded site splices should be carried out in accordance with Fig. 23.

#### The following requirements apply for the surface preparation of the surface areas A:

Before welding, residues of the masking lacquer applied to avoid zinc adherence should be removed completely from the area A of the welded site splice by partial mechanical grinding of the surface (degree of surface preparation: PMa). One must ensure that the area immediately next to the weld seam is free from possible zinc residues. The transition area between the area A (non-galvanised) and area B (hot-dip galvanized) should be carefully ground until a smooth transition is obtained.

The surface in area B should be affected as little as possible. It is absolutely essential to avoid treating or damaging the batch galvanised surface in area C by grinding. The intact zinc coating should thus be adequately protected or masked before execution the grinding operations.

After welding, the weld seams of the butt joints should be ground flush with the plate.

Before spray metallising in the surface areas A, the steel should be blasted in accordance with ZTV-ING Part 4, Section 3 [5] and EN ISO 2063 [16] using an abrasive defined by EN ISO 2063 [16], the desired surface finish is Sa 3 for a degree of roughness coarse (G), however with at least an average surface roughness of  $R_{y5} = 85 \mu\text{m}$  (G) in accordance with EN ISO 8503-1 [54]. It is recommended to use compressed air blasting for steel in accordance with EN ISO 8504-2 [37]. Melted coal slag, white corundum, hematite chilled iron grit or copper refinery slag should be used as the blast abrasive.

The intact zinc coating should be protected or masked adequately over a width of at least 300 mm, to avoid the blasting process causing damage to the batch galvanised surface. The aim is to have a clean, straightlined delineation between the areas A and B.

#### The following requirements apply for the surface preparation of the surface areas B:

Sweep blasting for zinc should be used for surface preparation in the transition area B, between the spray metallised and the substrate galvanised coatings.



The zinc surface is carefully roughened by gently blasting it with non-metallic abrasive over a width of at least 30 mm. The neighbouring areas C should be protected adequately against damage and contamination.

The sweep blasting parameters for the manual compressed air blasting must comply with the following criteria (in accordance with 'Verbände Richtlinie Duplex-Systeme' [38] and DIN 55633 [39]):

- abrasive particle size: 0.25 to 0.50 mm
- particle size of blasting abrasive: 0.25 bis 0.50 mm
- jet pressure at the nozzle: 2.5 to 3.0 bar
- jet angle:  $< 30^\circ$  to the surface (take component geometry into consideration).

The overlapping hot-dip galvanised area (area B) masked to the width mentioned has to be swept to a maximum average roughness  $R_{vs} = 40 \mu\text{m}$  (G). The maximum removal of the hot-dip galvanised layer must not exceed  $15 \mu\text{m}$ .

### **Spray metallising und sealing**

Spray metallising should be applied in accordance with the requirements of EN ISO 2063 [16]. One difference, however, is that the coating thickness has to be adapted to the requirement for the batch galvanised layer. ZnAl15 in accordance with EN ISO 2063 [16] should be used as the spray material.

The application of the spray material should be carried out using flame spraying.

According to ZTV-ING Part 4, Section 3 [5] sealing of the pores on the spray-metallised surface areas has to be applied promptly after spray metallising. The processing conditions and layer thicknesses for sealing given in the datasheet of the coating material manufacturer should be observed. The colouring of the sealing can be selected freely.

### **7.2.3 | Samples**

It is recommended to prepare separate samples from the steel envisaged for the project before fabricating the bridge components. The actual dimensions and process used should be taken into account and applied.

The samples serve to ensure that the necessary zinc layer thickness is achieved for a predicted corrosion protection period of 100 years, that the welded site splice is produced professionally including the repair, and if necessary to check the colour design of the sealing.

The number of samples necessary should be agreed in advance between the client and the contractor.

### **7.3 | Detail of bolted strapped joints**

Firstly, the regulations contained in EN 1993-1-8 [30] and EN 1090-2 [18] must be observed for the formation and execution of bolted strapped joints. Holes have to be drilled and not punched out because of the properties with respect to material fatigue, in particular with bolt bearing connections under shear stress, also with fitting bolts [40].

The fatigue resistance of bolted connections can be increased markedly by preloading the bolts.

By using a slip resistant connection, the surfaces to be joined are prepared by sweep blasting and subsequently covered with an alkali silicate coating to a thickness of  $50\text{-}80 \mu\text{m}$  in order to achieve the class B with a slip factor  $\mu = 0.4$  (cf. also Section 5.2).



Fig. 24: Bolted strap joint of the main girder of a composite bridge in Istanbul, Turkey

For long-lasting corrosion protection and avoidance of crevice corrosion, one has to make sure with a bolted joint that all crevices smaller than 1 mm are permanently sealed. For the straps at the components to be joined, there will usually be crevice widths below this minimum value so that conditions are favourable for crevice corrosion. With the above-mentioned procedure using the ASi coating it can be assumed that the applied coating will perform this sealing.

## 8 | Examination, monitoring, quality assurance

### 8.1 | Examination of the steel construction

The examinations of the steel construction specified in the relevant standards and codes for bridge construction have to be considered and executed. Additionally, one should carry out visual inspection of the galvanised components for macroscopically discernible damage and a systematic examination using the MT procedure in accordance with Annex 3 of DAST Guideline 022 [25] to eliminate possible crack formation as a result of liquid metal induced stress corrosion cracking. The critical points of the components to be examined are to be found in DAST Guideline 022 [25] or should be specified in an agreement between the client, structural engineer, steel constructor, inspection engineer and the galvaniser.

### 8.2 | Examination of zinc layer thickness

The examination of the layer thickness of zinc coatings is usually carried out using a magneto-inductive process (ISO 2808 [41]) or a magnetic process (ISO 2178 [42], ISO 3882 [43]). Measuring instruments based on the magnetic process determine either the magnetic attraction between a permanent magnet and the base material, which is affected by the presence of a coating, or the deterioration in the magnetic flux caused by the coating in the base material.

To obtain a representative result for the average coating thickness per unit/component, the number and position of the control surfaces and their size for the magnetic process must be chosen in accordance with the shape and size of the component or components. For this, the following recommendations are given in line with [5]:

- The zinc layer thickness should be measured on at least three components (test samples) of the same type.
- With a component surface area of more than 2 m<sup>2</sup>, the layer thickness should be checked on at least three control surfaces. With smaller surface areas, the number of control areas can be reduced.

- With long parts, the control area must be about 100 mm from holes and 100 mm from the ends of the components and about in the middle of the component and must enclose the whole cross-section of the part. For each control area, the zinc layer thickness should be recorded using five single measurements (local zinc layer thickness). The examination to determine compliance with the specified layer thickness is carried out using the average value of the individual measurements for each control area (average zinc layer thickness). According to [9], the locally determined zinc layer thickness may be up to 20% below the specified zinc layer thickness in individual cases, provided the average value of each control area fulfils the layer thickness requirement.

The zinc layer thickness on the bridge components should be checked in accordance with the above-mentioned requirements directly after hot-dip galvanising. If the layer thickness is significantly below the required minimum value, further measures have to be agreed with the client with respect to the reduced duration of the corrosion protection.

In addition, in accordance with ZTV-ING [5], control surfaces should be envisaged at the following points:

- construction areas in which a repair of the corrosion protection coating is associated with high costs, e.g. for scaffolding, or with notable interference with operations
- locations that are characteristic of localised corrosive impact (e.g. areas above the carriageway of roads treated with de-icing salt).

The control surfaces have to be marked according to type, size and position in a corrosion protection plan. A control surface record is to be maintained according to Annex B of ZTV-ING [5].

### 8.3 | Quality assurance of spray metallising

The quality assurance of spray metallising is carried out in accordance with the requirements of EN ISO 14922 Parts 1 to 3 [44]. The specialist company conducting the work must be appropriately qualified in accordance with [44] to carry out spray metallising. All thermal sprayers must be approved and have successfully completed a suitable examination in accordance with EN ISO 14918 [45]; all test certificates must be kept up to date. According to EN ISO 12690 [46], the manufacturer has to have suitable facilities and personnel for supervising the spraying operations, who control the proper execution of the work.

Examination of the layer thicknesses has to be carried out in accordance with EN ISO 2178 [42]. The layer thickness has to be measured at at least three different positions for each area (A, B and C in Fig. 23) and checked for conformity with the specified requirements. A possible adhesion test has to be carried out according to Annex A of EN ISO 2063 [16], however only on a suitable sample because it involves destructive examination. If the process described in Section 3.4 is adhered to, though, one can assume that the bonding strength is adequate.

The control areas have to be marked according to type, size and position in a corrosion protection plan. A control surface record is to be maintained according to Annex B, ZTV-ING [5] and attached to the construction documentation.

## 9 | Economic considerations

### 9.1 | General

The reduced fatigue resistance of hot-dip galvanised steel components may lead to the assumption that this has a decisive effect on the dimensioning of the supporting structure and that cross-sections must thus be larger than the non-galvanised version. This is contradicted by the fact that especially with road bridges in most cases the fatigue assessment does not have a very high degree of utilisation so that there are still reserves. Thus there is probably cost neutrality with regard to the steel used. This is also supported by various studies [36] [47] [48]. Only in the case of unfavourable combinations of short span, high steel grade and high static utilisation it might be necessary to increase the cross-sections.

Additional measures required at the connections of girders that are longer than about 16 m will possibly result in an additional effort. This is due to the limited zinc bath dimensions available. Depending on the type of connection – bolted or welded – different measures have to be taken that have a significant impact on the fabrication costs.

Studies conducted by BAST [51] and TU Dresden [49] show in an exemplary manner, however, that even if the initial costs are considered, a hot-dip galvanised bridge can offer the most economical solution.

If one considers the life cycle of the bridge, possible extra costs during fabrication as a result of increasing the cross-section and/or additional connections are saved again. Even after 33 years, i.e. after the first repair interval for an organic corrosion protection coating, the life-cycle costs are significantly more favourable than with conventional corrosion protection systems [36] [49].

### 9.2 | Effects of reduction in detail notch category

The partially necessary down-grading of the notch detail categories of hot-dip galvanised details compared with standardised, non-galvanised details raises the question of the effect of a possible increase in the use of material and, linked to this, the cost economy of a hot-dip galvanised bridge. For clarification, a comparative calculation was conducted on a composite bridge typical for the intended application [47].

The comparison was based on the following bridge characteristics:

- traffic bridge over a river in a rural area
- span: 35.30 m (no central support)
- carriageway width: 8.50 m (two-lane)
- overall width between balustrades: 13.75 m
- bridge area: 485 m<sup>2</sup>
- steel grade: S355J2+N

The construction was dimensioned to accommodate the static loads to LM 1 in accordance with [50]. The structural analysis results in a maximum steel stress of 351 N/mm<sup>2</sup>, which corresponds to a utilisation degree of 99% of the relevant cross-section.

The assessments of the resistance to material fatigue were carried out using the fatigue load model LM 3 according to DIN Fachbericht 101 resp. EC 1-2 [50]. As a result, the decisive component was a butt joint assumed to be in the middle of the most highly loaded field range.

The form of the verification is:

$$\gamma_{Ff} \cdot \Delta\sigma_{E,2} \leq \Delta\sigma_c / \gamma_{Mf} \quad (9.1)$$

where  $\gamma_{Ff} = 1.0$  und  $\gamma_{Mf} = 1.15$  (accessible, high consequential losses).

and

$$\Delta\sigma_{E,2} = \lambda \cdot \Phi_2 \cdot \varphi_{fat} \cdot \Delta\varphi_{fat} \cdot \Delta\sigma_P \quad (9.2)$$

The factor  $\varphi_{fat}$  was introduced additionally. To assess material fatigue,  $\varphi_{fat}$  was taken to be = 1.2 (good because carriageway surface is new) and  $\varphi_{fat} = 1.0$  (verification within area of span): according to [21] the dynamic coefficient  $\Phi_2$  is also equal to 1.0 because  $\Phi_2$  is already included in the fatigue load model. The damage equivalent factor  $\lambda$  was used with the maximum value  $\lambda = \mu_{max} = 2.0$ . The equivalent constant amplitude stress range was  $\Delta\sigma_{E,2} = 62$  N/mm<sup>2</sup>. Thus in this case the verification is:

$$1.0 \cdot 62 \text{ N/mm}^2 \leq 80/1.15 = 70 \text{ N/mm}^2 \\ (\text{utilisation grade} = 89\%)$$

An across-the-board reduction on the resistance side of one notch detail category for taking the effect of the hot-dip galvanising into consideration would be conservative from various perspectives. On the one hand, for the detail here, 'longitudinal weld over transverse weld', the detail category 80 is also confirmed for the hot-dip galvanised execution, and on the other hand the worst but improbable case was assuming that the connection is exactly in the middle of the span. With one category lower, detail category 71, compared with the above-mentioned Table 4, this results in the following:

$$1.0 \cdot 62 \text{ N/mm}^2 \leq 71/1.15 = 62 \text{ N/mm}^2$$

(utilisation grade = 100%),

whereby the verification of the fatigue assessment is still fulfilled. This means that despite the reduction of the fatigue resistance there is no need to choose larger cross-sections. In the example investigated, no additional steel is thus required, which means cost neutrality with regards to steel consumption.

### 9.3 | Sources of cost

Besides the cost of the batch galvanising itself and the obligatory cost for transport from the steel construction company to the galvanising plant, with larger bridge structures (from approx. 16 m span upwards) other costs arise in terms of the production of site joints (cf. Section 7) because of the limited zinc bath dimensions. These costs are mainly divided into additional preparation measures, welding work and subsequent post-processing of the corrosion protection. In addition, samples for quality assurance and measurement of the zinc layer thickness may be necessary.

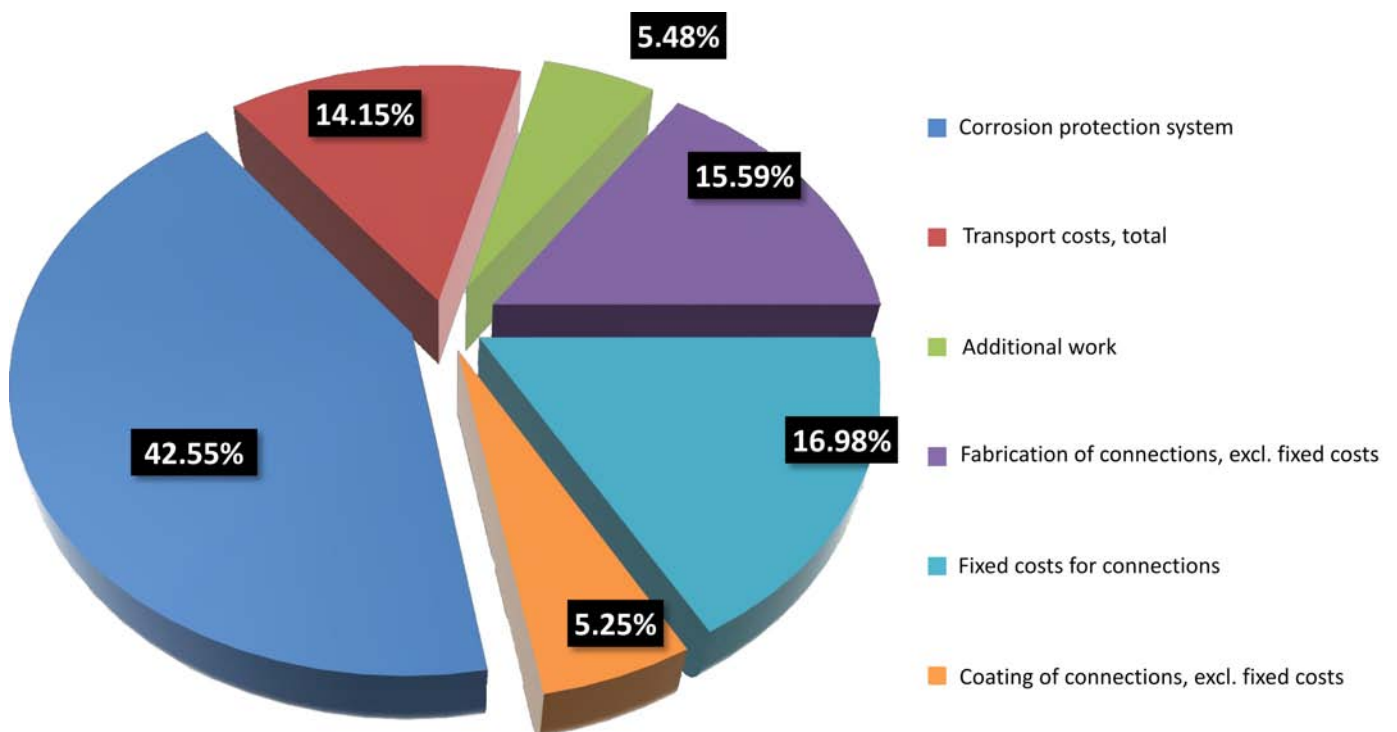

Fig. 25: Breakdown of the costs for the zinc-coating corrosion protection system [3]

Fig. 25 gives an overview of the distribution of the costs for the hot-dip galvanising corrosion protection system for a demonstration object [3].

If one compares hot-dip galvanising with an organic coating, the total costs for the initial investment are of about the same magnitude. Only the cost distribution is different (Fig. 26). The proportion of the costs for the hot-dip galvanising itself, without the additional costs for transport, are initially lower than for an organic coating applied in the factory. However, the additional costs for the necessary measures for connections eliminate this advantage and result in cost neutrality. Therefore there will be decisive cost benefits for hot-dip galvanising, if no connections are required in case of very short spans. Project-specific variations are possible here and must be checked where necessary.

## 9.4 | Cost of corrosion protection for service life of 100 years

Even at the start of construction the corrosion protection system for batch galvanising with a coating thickness greater than 200 µm can already represent a lower initial investment and thus the more economical choice up to a corrosivity category C4. A repair of the zinc coating is not expected to be necessary, which means the economic benefits of a hot-dip galvanised bridge are to be expected during the course of the construction's life cycle at the latest.

Precise statements regarding cost economy always depend on the certainty with which one can predict the corrosion behaviour over the planned service life of 100 years. Fluctuations in the corrosive impacts compared

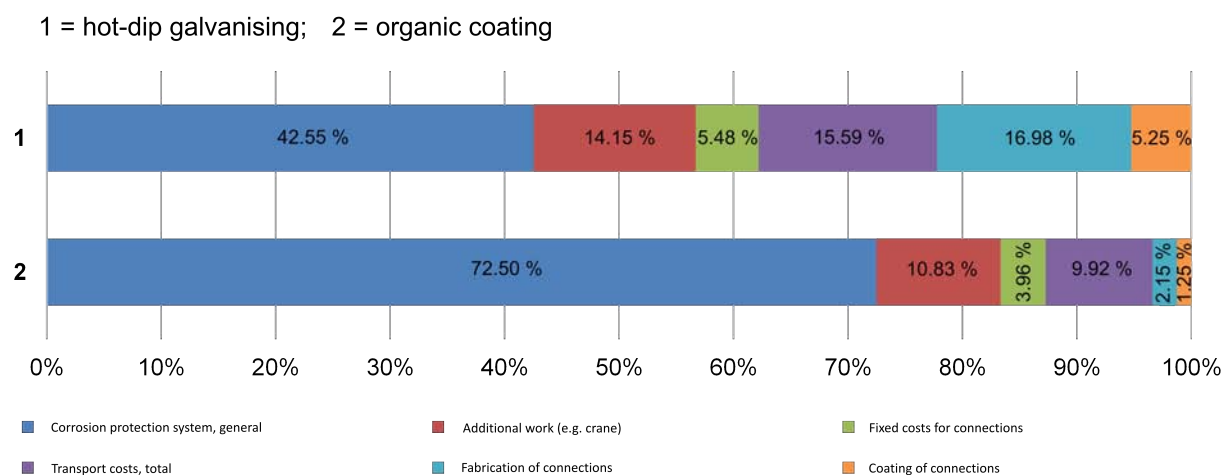

Fig. 26: Cost of the corrosion protection, divided according to system [3]



with the assumed effect can occur during the service life of the construction and affect the protection period of the zinc coating as a result of changes to the ambient conditions. If one takes the most unfavourable case of enhanced corrosivity and assumes at the most one repair of the hot-dip galvanised corrosion protection during the lifetime of the bridge (cf. Section 3.3), there will still be a saving of at least one repair compared with protection by organic coatings, which in total will lead to a cost saving over the complete life cycle of the bridge [36] [51].

A comparison of the life-cycle costs for a bridge construction with different corrosion protection systems was carried out as part of a research project of the German Federal Highway Research Institute (BAST) [51]. An organic coating that would have to be repaired twice during the life cycle of the bridge, was compared with hot-dip galvanising in two different layer thicknesses. It was assumed that the corrosion protection of the thinner hot-dip galvanised layer would need to be repaired after about 66 years by applying an organic coating.

The calculation of the fabrication costs shows that hot-dip galvanising already leads to a reduction compared with

the organic coating and further savings ensue during the service life because of the elimination of maintenance measures and the resultant external costs, such as traffic jams, which were also determined.

If one considers only the external costs (environmental impacts due to vehicle operation, costs of vehicle operation and costs due to delays, see Fig. 28), differences occur above all in the 66th year of the life cycle, when besides other work the second complete replacement of the organic coating or the repair of the thinner zinc layer is due (cf. Table 5 in the following section on sustainability assessment). The origin of external costs of approx. 0.7 million euros for the hot-dip galvanised variant B (without the repair of the hot-dip galvanising) results from maintenance measures for the concrete that are then necessary to the superstructure and is not caused by the steel girder. Altogether there is a cost advantage for hot-dip galvanising (variant B) of 20% and even one of 12% for variant C (organic coating of the hot-dip galvanised steel girder in the 66th year) compared with the total external costs for variant A executed with a coating.

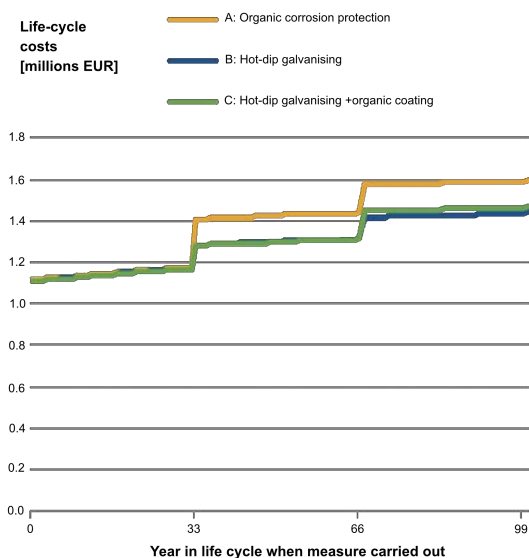

Fig. 27: Development of life-cycle costs for the corrosion protection variants investigated [51]

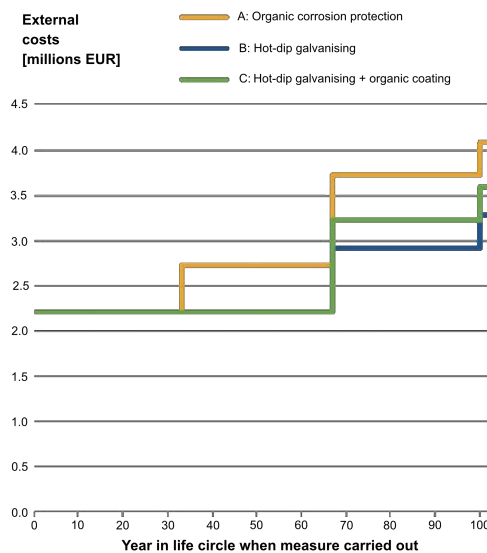

Fig. 28: External costs over the complete life cycle for the three variants [51]

## 10 | Sustainability assessment

### 10.1 | General information on galvanising

Like steel, zinc can be recycled simply and infinitely. According to the Industrieverband Feuerverzinken e.V. trade association, the current recycling rate for zinc is 80%. For example, used galvanised products are completely recycled with other steel scrap during the electric steel production process. The zinc volatilises very early in the process and can be captured as so-called electric arc furnace (EAF) dust, which is recycled in special plants and returned to the primary zinc smelter.

In addition to galvanised steel products, by-products from the galvanising process are also reclaimed to the greatest possible extent. Zinc ash, which results from the oxidation of the zinc bath surface, and hard zinc, a mixture of zinc and iron that collects at the bottom of the galvanising bath, are collected systematically during the galvanising process and sent for recycling.

## 10.2 | Sustainability assessment

### 10.2.1 | University of Berlin Study

In order to assess the environmental impact of the hot-dip galvanising process, University of Berlin carried out a study into corrosion protection systems for steel structures. A coating in accordance with EN ISO 12944 [24] and hot-dip galvanising in accordance with EN ISO 1461 [9] were investigated based on the life-cycle assessment method. For both systems, a service life of 60 years with the corrosivity class C<sub>3</sub> was assumed.

In the case of the coating, it was assumed that maintenance would be carried out twice, after 20 and 40 years. As a result it could be shown that for a long-life steel construction the hot-dip galvanising corrosion protection system posed less environmental impacts than a coating system.

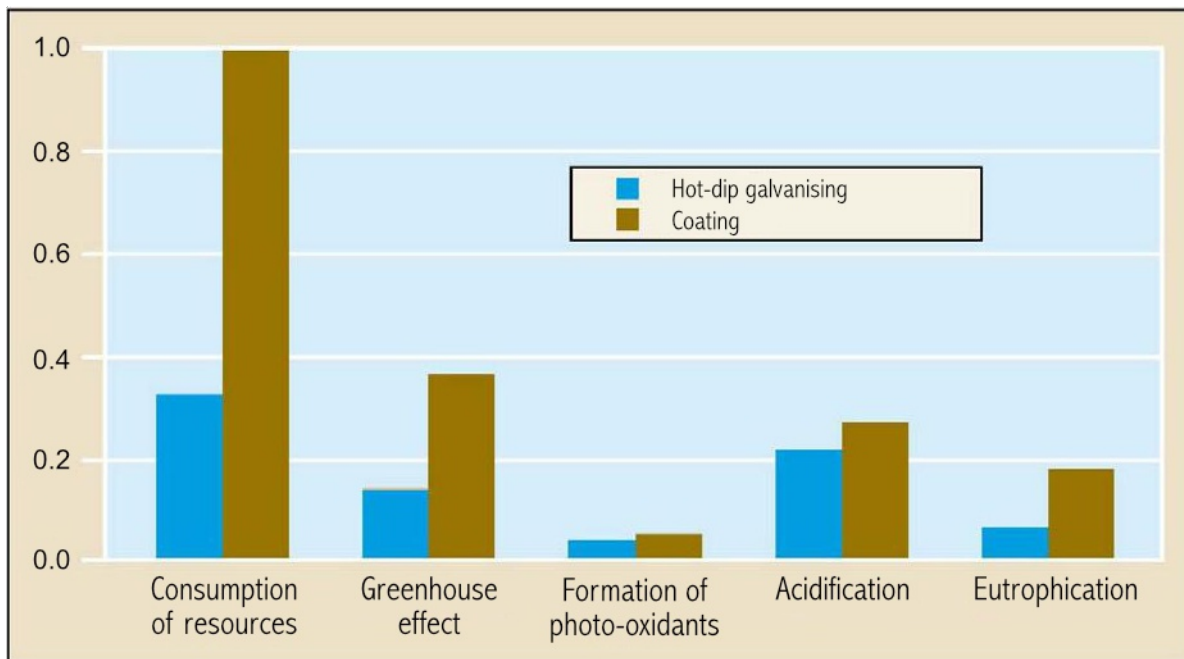

Fig. 29: Pollution comparison in various impact categories [52]

## 10.2.2 | BAST Study

As part of a research project of the Federal Highway Research Institute (BAST) [51], the sustainability of different corrosion protection systems was investigated based on a real bridge construction project (cf. Section 9.4). A life-cycle assessment was conducted for the whole life cycle – from the fabrication via the service life to deconstruction – for the integral autobahn crossover investigated with a span of 45 m; the life cycle costs and the external impacts were determined and compared for three variants.

The construction data and the fabrication processes for the bridge were determined. Reasonable assumptions were made for maintenance during the use phase. This was based on the so-called ‘condition-based maintenance strategy’ (cf. Table 5) [2] [51] [53]. This envisages a grouping of measures after 33 and 66 years of the life cycle. Assumptions were also made for the end of the life cycle for the dismantling process and the materials obtained.

As a result, it was determined that the increased environmental impacts from the fabrication process for the hot-dip galvanised bridge variant are compensated for during the service life.

The necessary traffic interference due to refurbishment measures (e.g. speed restrictions in the area where work is being carried out) results in increases in pollutant emissions and fuel consumption. For the variants investigated, these emissions result not only in costs, but also in environmental impacts, that are of the same magnitude and sometimes even greater than those due to the construction of the bridge itself. The calculation of the vehicle operating costs and costs due to delays (cf. Fig. 28) showed that these external costs exceed the life-cycle costs of the bridge construction for all variants, too. It is important therefore to limit refurbishment measures to a minimum not only for economic but also for environmental reasons. Here, the use of hot-dip galvanising as corrosion protection can make a significant contribution.

Table 5: Maintenance scenario: ‘Condition-based maintenance strategy’

Year	Maintenance Measure
0	<i>Fabrication</i>
17	Carriageway: surface
33	Complete replacement of the organic corrosion protection coating Carriageway: surface + surface and sealing Cornices, drainage, protection / restraint systems
50	Carriageway: surface
66	Complete replacement of the organic corrosion protection coating or maintenance of the hot-dip galvanising in case of thinner coating layer by applying an organic coating Maintenance of concrete Carriageway: surface and sealing Cornices, drainage, protection / restraint systems
83	Carriageway: surface
100	<i>Dismantling</i>

### 10.3 | Environmental product declaration (EPD)

Among other things, detailed information on the construction products used is necessary to calculate the environmental impacts of a construction over its complete life cycle. Environmental labelling, which is classified as Type III according to the ISO systematics, are referred to as environmental product declarations (EPDs) and for construction products are based on the EN ISO 14025 and EN 15804 standards. They contain quantitative product information that originates from a life-cycle assessment and have to be verified by an independent third party. EPDs serve to provide objective and detailed information about a product and its properties with respect to resultant environmental impacts. Besides information from the life-cycle assessment, EPDs can contain further technical information. Thus among other things they can serve as a reliable basis for data for the life cycle analysis of a construction and as proof of the necessary properties of construction products.

Since 2013 an environmental product declaration has existed for hot-dip galvanised structural steel, prepared on the basis of the EPD for structural steels (hot rolled sections and plates) and verified by Institut Bauen und Umwelt (IBU) as the independent third party [55][56]. It contains objective data and facts on the impact of structural steels and hot-dip galvanised structural steels on the environment so that with the help of the EPDs reliable and transparent environmental data can be provided. Both environmental product declarations are valid for five years and are freely accessible at [www.ibuepd.com](http://www.ibuepd.com) and at [www.bauforumstahl.de](http://www.bauforumstahl.de).

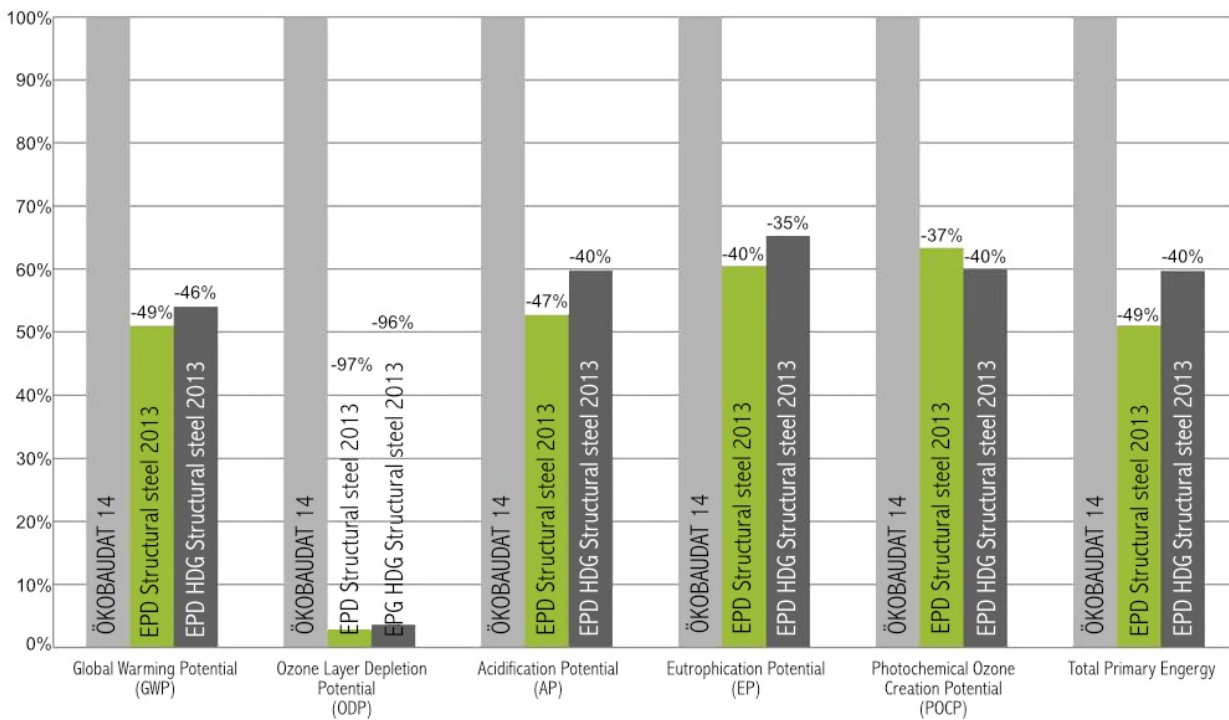

Fig. 30: Comparison of ÖKOBAUDAT14 (data set non-galvanised structural steel) with the EPDs for structural steel [57] and hot-dip galvanised structural steel (2013) [56]. The recycling potential was taken into account in all data sets.

If one compares the data of both EPDs for structural steel with the average values for Germany from ÖKOBAUDAT, the official database of the federal ministry responsible for construction at [www.oekobaudat.de](http://www.oekobaudat.de), it can be seen that the environmental data given in the EPDs are significantly below the average values (Fig. 30).

This reflects the fact that the steel producers considered in the EPD are leaders in environmental technology as a result of their locations in Europe and produce steel in a particularly resource-efficient manner. The environmental data for hot-dip galvanised structural steel are at least 35% below the figures given in ÖKOBAUDAT for non-galvanised structural steel, even lower still in the case of individual environmental parameters. By using the products covered by these EPDs one can achieve a significantly better environmental performance, even when hot-dip galvanising is included.

With respect to environmental impacts, hot-dip galvanising proves that it is a so-called longer life product. It only contributes a small amount to the environmental impact, but has a major influence on the long service life of the steel. In case of the most commonly considered indicators, namely global warming potential and total primary energy (renewable and non-renewable), the hot-dip galvanising process's contribution is only 6% or 13% respectively (Fig. 31).

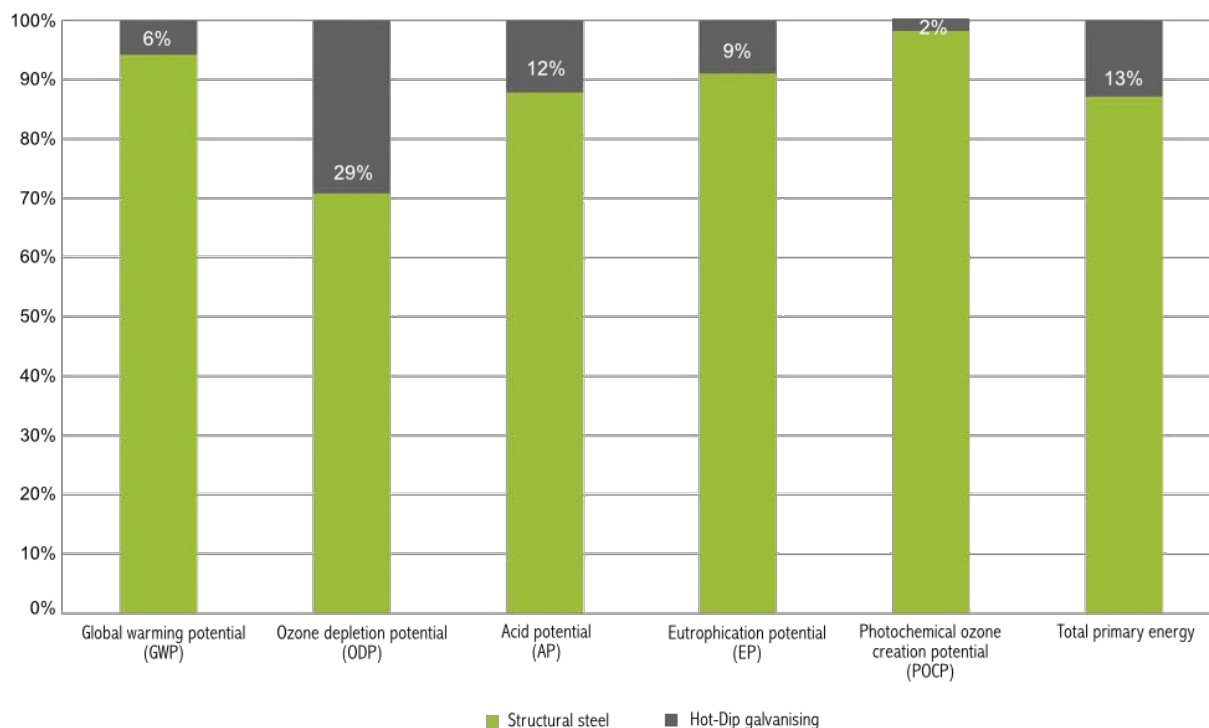

Fig. 31: Relative contributions of steel production and hot-dip galvanising to selected impact categories

## 11 | Summary

For decades, batch galvanising has been a tried and proved method of corrosion protection in steel structural engineering and based on its technical merits it offers long-lasting, economical and sustainable solutions in a broad range of steel applications. Until now, it has not been permitted for use for load-bearing components in bridge construction, because of the lack of fundamental knowledge relating to the behaviour of batch-galvanised elements under cyclic loading.

In order to fill this knowledge gap, manifold investigations have been carried out in recent years to clarify the effect of the zinc layer on the fatigue behaviour of steel construction details. Based on the knowledge gained about the microscopic processes taking place due to the combined effect of the zinc layer and the underlying steel, as well as the macroscopic effects on the construction details, appropriate approaches for the structural design have been derived. Furthermore, the effectiveness of spray metallising as a standard method of corrosion protection in the area of corrective welding has been investigated and a standard procedure for its use has been prepared.

Extensive cost analyses and a comparative life-cycle assessment show that hot-dip galvanising is an economical and sustainable alternative to conventional corrosion protection systems, especially in the field of small and medium spans.

In this brochure the most relevant results from the basic research into the use of hot-dip galvanised components in steel and composite bridges are summarised and processed in a manner geared to practical needs as well as being extended to include important aspects of construction practice with regard to planning, design and execution of galvanised bridge supporting structures. The necessary adaptations to structural design are easy to implement and the constructional design of the bridge segments and the necessary butt joints are oriented towards principles with which the design engineer is familiar. The same applies on the steel construction side to the fabrication, erection and quality assurance at the construction site.

A brochure cannot cover every aspect and question arising from each and every construction project. Because of the innovative nature of the use of hot-dip galvanising in bridge construction with its specific requirements and peculiarities for planners, steelwork fabrication and galvanising facilities, it is recommended that the project participants communicate with each other intensively and at an early stage during all phases of a project.

The codes of practice and recommendations presented here enable planners to design the protection system for structural steel using hot-dip galvanising for a service life of 100 years as it is usual in bridge construction. The results presented and the statements regarding cost economy and sustainability can be used as a decision making aid in the course of planning a new construction.



## 12 | Refernces and documents

- [1] Gunreben, Y.-C.  
Brückenertüchtigung - Stand und Ausblick, in BAST  
Expertengespräch Stahlbrückenbau,  
Bergisch Gladbach, 09/2014.
- [2] Kuhlmann, U.; Maier, Ph; Silva, L. da; Gervásio, H.;  
Brett, Ch; Schröter, F.; Willms, R.; Lehnert, T.;  
Popa, N.; Zanon, R.; Orcesi, A.; Ta, N.-B; Thiery, M.;  
Nielsen, K.; Andersen, R.; Knudsen, A.; Barros, P.;  
Perdigão, V.; Martins, N.; Tardivel, Y.; Robe,  
Sustainable steel-composite bridges in built  
environment (SBRI), Brussels, RFCS final report,  
RFSR-CT-2009-00020, 2013.
- [3] Ungermann, D.; Rademacher, D.; Oechsner, M.;  
Landgrebe, R.; Adelman, J.; Simonsen, F.;  
Friedrich, S.; Lebelt, P.  
Feuerverzinken im Stahl- und Verbundbrückenbau,  
IGF-No. 351/ZBG, FOSTA P835, Düsseldorf,  
Research report, 2014.
- [4] DIN-Fachbericht 103 "Stahlbrücken", 2009.
- [5] BAST – Bundesanstalt für Straßenwesen  
ZTV-ING Stahlbauten: Zusätzliche Technische  
Vertragsbedingungen und Richtlinien für  
Ingenieurbauten -Teil 4 Abschnitt 3:  
Korrosionsschutz von Stahlbauten (ZTV-ING), 2010.
- [6] BAST – Bundesanstalt für Straßenwesen  
TL/TP-KOR- Stahlbauten: Technische Liefer-  
bedingungen und Technische Prüfvorschriften für  
Beschichtungsstoffe für den Korrosionsschutz von  
Stahlbauten, 12/2002.
- [7] EN ISO 12944-5, Paints and varnishes - Corrosion  
protection of steel structures by protective paint  
systems - Part 5: Protective paint systems, 2008.
- [8] ArcelorMittal Commercial Sections  
Bridges with hot-rolled sections, 2010.
- [9] EN ISO 1461, Hot dip galvanized coatings on  
fabricated iron and steel articles - Specifications and  
test methods, 2009.
- [10] EN ISO 12944-2, Paints and varnishes - Corrosion  
protection of steel structures by protective paint  
systems - Part 2: Classification of environments,  
1998.
- [11] Paul, M.  
Vorlesung über Korrosion und Korrosionsschutz von  
Werkstoffen Teil 1. Wuppertal: TAW-Verlag, 1996.
- [12] Schikorr, G.  
Die Bedeutung des Schwefeldioxyds für die  
atmosphärische Korrosion der Metalle, Materials and  
Corrosion, no. 6, 1964.
- [13] Ungermann, D.; Rademacher, D.; Oechsner, M.;  
Simonsen, F.; Friedrich, S.; Lebelt, P.  
Hot-dip galvanizing in bridge construction - Part 2;  
Using hot-dip galvanizing as a lifetime corrosion  
protection for bridge constructions, Stahlbau,  
vol. 84, no. 2, pp. 119-123, 2015.
- [14] EN ISO 9224, Corrosion of metals and alloys –  
Corrosivity of atmospheres – Guiding values for the  
corrosivity categories, 2012.
- [15] EN ISO 9223, Corrosion of metals and alloys –  
Corrosivity of atmospheres – Classification,  
determination and estimation, 2012.
- [16] EN ISO 2063, Thermal spraying - Metallic and  
other inorganic coatings - Zinc, aluminium and their  
alloys, 2005.
- [17] EN ISO 8501-3, Preparation of steel substrates  
before application of paints and related products –  
Visual assessment of surface cleanliness – Part 3:  
Preparation grades of welds, edges and other areas  
with surface imperfections, 2007.
- [18] EN 1090-2, Execution of steel structures and  
aluminium structures - Part 2: Technical  
requirements for steel structures, 2011.
- [19] EN ISO 14713, Zinc coatings - Guidelines and  
recommendations for the protection against  
corrosion of iron and steel in structures, 2009.
- [20] EN 1993-1-9, Design of steel structures - Part 1-9 -  
Fatigue, 2010.

- [21] EN 1993-2, Design of steel structures - Part 2 - Steel Bridges, 2010.
- [22] EN 1994-2, Design of composite steel and concrete structures - Part 2: General rules and rules for bridges, 2010.
- [23] EN 10025-2, Hot rolled products of structural steels – Part 2: Technical delivery conditions for non-alloy structural steels, 2005.
- [24] EN ISO 12944-3, Paints and varnishes – Corrosion protection of steel structures by protective paint systems – Part 3: Design considerations, 1998.
- [25] Deutscher Ausschuss für Stahlbau  
DAST-Guideline 022, Hot-dip galvanising of structural steel, 2009.
- [26] Pinger, T.  
Zur Vermeidung der Rissbildung an Stahlkonstruktionen beim Feuerverzinken unter besonderer Berücksichtigung der flüssigmetall-induzierten Spannungsrissskorrosion, Diss. RWTH Aachen, 2009.
- [27] EN 10163-2, Delivery requirements for surface conditions of hot-rolled steel plates, wide flats and sections - Part 2: Plate and wide flats, 2005.
- [28] Pinger, T.  
Thermodynamische Effekte beim Feuerverzinken und deren Beherrschung, Konstruktion, pp. 62-67, 6/2013.
- [29] EN 1993-1-10, Design of steel structures - Part 1-10: Material toughness and through-thickness properties, 2010.
- [30] EN 1993-1-8, Design of steel structures - Part 1-8 - Design of Joints, 2010.
- [31] EN 1993-1-1, Design of steel structures - Part 1-1: General rules and rules for buildings, 2010.
- [32] Kammel, C. und Sedlacek, G.  
Dauerverhalten von GV-Verbindungen bei verzinkten Konstruktionen im Freileitungs-, Mast- und Kaminbau, Forschungsvereinigung Stahlanwendung e.V., Düsseldorf, Forschungsbericht P 409, 2001.
- [33] Valtinat, G.; Albrecht, F.; Dangelmaier, P.  
"Gleitfeste Verbindungen mit feuerverzinkten Stahlteilen und reibfesten Beschichtungen oder anderen reibbeiwert erhöhenden Maßnahmen", Hamburg, Gemeinschaftsausschuss Verzinken e.V. (Hrsg.) Bericht 122, 1993.
- [34] Rademacher, D. und Simonsen, F.  
Zum Einfluss der Feuerverzinkung auf die Ermüdungsbeanspruchbarkeit im Brückenbau, in 18. DAST-Kolloquium, Aachen, 2012, pp. 119-124.
- [35] Ungermann, D.; Rademacher, D.; Oechsner, M.; Simonsen, F.; Friedrich, S.; Lebelt, P.  
Hot-dip galvanizing in bridge construction - Part 1: Using hot-dip galvanized steel for cyclic loaded structures Stahlbau, vol. 84, no. 1, pp. 2-9, 2015.
- [36] Wentzek, D.  
Wirtschaftlichkeitsvergleich und konstruktive Ausbildung von feuerverzinkten Stahl-Verbundbrücken mittlerer Spannweite, Lehrstuhl Stahlbau, TU Dortmund, Diplomarbeit, 2013.
- [37] EN ISO 8504-2, Preparation of steel substrates before application of paints and related products - Surface preparation methods - Part 2: Abrasive blast-cleaning, 2002.
- [38] Industrieverband Feuerverzinken e.V.  
Verbände-Richtlinie Korrosionsschutz von Stahlbauten – Duplex-Systeme – Feuerverzinkung plus Beschichtung – Auswahl, Ausführung, Anwendung, 2000.
- [39] DIN 55633, Beschichtungsstoffe – Korrosionsschutz von Stahlbauten durch Pulver-Beschichtungssysteme – Bewertung der Pulver-Beschichtungssysteme und Ausführung der Beschichtung, 2009.
- [40] Valtinat, G. und Huhn, H.  
Scher-Lochleibungs-Verbindungen mit feuerverzinkten Stahlbauteilen und gestanzten Löchern unter Betriebsbeanspruchung, Gemeinschaftsausschuss Verzinken e.V. (Hrsg.) Bericht Nr. 145, 1994.
- [41] EN ISO 2808, Paints and varnishes – Determination of film thickness, 2007.

- [42] EN ISO 2178, Non-magnetic coatings on magnetic substrates - Measurements of coating thickness - Magnetic method, 1995.
- [43] EN ISO 3882, Metallic and other inorganic coatings - Review of methods of measurement of thickness, 2003.
- [44] EN ISO 14922, Thermal spraying - Quality requirements of thermally sprayed structures, 1999.
- [45] EN ISO 14918, Thermal spraying - Approval testing of thermal sprayers, 1999.
- [46] EN ISO 12690, Metallic and other inorganic coatings –Thermal spray coordination – Tasks and responsibilities, 2011.
- [47] Schwär, R.  
Konstruktive Gestaltung von feuerverzinkten Stahl- und Verbundbrücken - Entwicklung von feuerverzinkungsgerechten Konstruktions- und Fertigungsdetails, Lehrstuhl Stahlbau, TU Dortmund, Master-Thesis, 2013.
- [48] Stadie, M.  
Der Einfluss der Feuerverzinkung auf die Dimensionierung der Stahlträger und Details, untersucht an Verbundbrücken mit gewalzten Stahlträgern unter besonderer Berücksichtigung ihrer Wirtschaftlichkeit, TU Dortmund, Lehrstuhl Stahlbau, Master-Thesis, 2015.
- [49] Rebel, A.  
Beschichtungssysteme für den Korrosionsschutz von Brückenbauwerken im Wirtschaftlichkeitsvergleich, TU Dresden, Diplomarbeit, 2014.
- [50] EN 1991-2, Actions on structures – Part 2: Traffic loads on bridges, 2010.
- [51] Kuhlmann, U.; Maier, Ph.; Ummenhofer, T.; Zinke, T.; Fischer, M.; Schneider, S.  
Untersuchung zur Nachhaltigkeitsberechnung von feuerverzinkten Stahlbrücken, Bergisch Gladbach, final report BAST-Vorhaben FE 089.0291/2013, 2014.
- [52] Industrieverband Feuerverzinken e.V.  
Special: Nachhaltigkeit", Feuerverzinken, 2008.
- [53] Beck, T.; Fischer, M.; Friedrich, H.; Kaschner, R.; Kuhlmann, U.; Lenz, K.; Maier, P.; Mensinger, M.; Pfaffinger, M.; Sedlbauer, K.; Ummenhofer, T.; Zinke, T.  
Maintenance strategies as a basis für the holistic assessment of steel and composite bridges according to criteria of sustainability, Stahlbau, vol. 1, no. 82, pp. 3-10, 2013.
- [54] ISO 8503-1, Preparation of steel substrates before application of paints and related products- Surface roughness characteristics of blast-cleaned steel substrates - Part 1: Specifications and definitions for ISO surface profile comparators, 2013.
- [55] EPD-BFS-20130173-IBG1, Environmental Product Declaration Hot-dip galvanized structural steel: Sections and plates, Institut Bauen und Umwelt (IBU), Berlin, 2013
- [56] EPD-BFS-20130094-IBG1, Environmental Product Declaration Structural steel: Sections and plates, Institut Bauen und Umwelt (IBU), Berlin, 2013





# Unser Schutz ist stärker als Sonne, Wind und Regen

Feuerverzinker machen Werte wetterfest

Denn Stahl ist die Basis für nachhaltiges Bauen – beständig verzinkt für wartungsfreie Stahlbauten mit herausragender Nutzungsdauer.



Stahl – nachhaltig wartungsfrei – für das Parkhaus P58 am Flughafen Frankfurt. Mehr dazu unter: [www.stahlbauverbindet.de](http://www.stahlbauverbindet.de)

Stahlbau verbindet: Menschen, Leben, Generationen





Members of bauforumstahl .....



Associations .....

